

MOTTURA

SOLUZIONI ALLA LUCE DEL SOLE

TENDE A
PANNELLO
PANEL TRACK SYSTEMS



Oriente



LE QUALITÀ DI UNA GAMMA COMPLETA

Oriente è il programma di sistemi per tende a pannelli. L'ultima generazione di una linea di prodotto da sempre presente nell'offerta di sistemi tecnologici di Mottura in cui **funzionalità e qualità**, come sempre, sono le priorità nei sistemi Mottura. Oriente può essere formato da **2, 3, 4, o 5 vie**, su cui possono essere fissati diversi pannelli di tessuto, liberi o vincolati. **Silenziosità e scorrevolezza** sono il risultato di una tecnologia sofisticata che garantisce una prestazione ed una longevità superiori. È un sistema applicabile a soffitto o a parete e su cui possono essere utilizzati tessuti della collezione **Tecnica by Mottura**, con le più molteplici caratteristiche tecniche. Oriente è disponibile di serie nelle seguenti varianti colori: alluminio satinato e cromato, bianco lucido e nero opaco.

THE QUALITIES OF A FULL RANGE

Oriente is a range of panel curtain systems. It represents the latest generation of a product line that has always been part of Mottura's range of technological systems, where **functionality and quality** remain, as always, the top priorities. Oriente can be configured with **2, 3, 4 or 5 ways**, to which various fabric panels, both fixed and free, can be attached. **Silent operation and smooth gliding** are the result of sophisticated technology that guarantees superior performance and longevity. It is a system suitable for ceiling or wall mounting, on which fabrics from the **Tecnica by Mottura** collection can be used, offering a wide range of technical characteristics. Oriente is available in the following colours: satined or chromed aluminium, glossy white, as standard.

GLI AZIONAMENTI

Oriente offre ogni soluzione in termini di azionamento. Azionamento manuale a pannelli liberi: i teli vengono posizionati manualmente e sono sovrapponibili in qualsiasi posizione per tutta la superficie che si intende arredare con il sistema. Azionamento manuale con asta di comando: i teli sono agganciati l'uno all'altro in modo tale che il movimento di uno di essi provochi anche lo spostamento degli altri. Azionamento a corde: i teli sono agganciati l'uno all'altro ma l'azionamento di essi è a corda. È una soluzione consigliabile per tutti i tessuti delicati. È possibile anche l'utilizzo in parallelo con Power 541 sia azionamento a pulsante che wireless con comando radio R.F. M2net.

OPERATING

Oriente offers every suitable solutions in terms of operation. Not-hooked hand drawn operated panels: the fabric panels are manually placed and are stackable in any position for the entire surface that you desire to decorate with the system. Manual operation with control rod: the curtains are attached one to the other, in such a way that the movement of one of them also causes the displacement of the other. Drive to ropes: the panels are, also in this case, hooked one to another but the operating is with cord. It is a advisable solution for all of the delicate fabrics. Motorized. Oriente can be used in parallel with Power 541/571 both by press switch and wireless with M2net solutions.



Nippo

Design e qualità le priorità di Nippo, la gamma di sistemi per tende a pannelli più particolare e nuova, rivolta al mondo dell'interior design.

Design and quality are priorities of Nippo, the range of systems for japanese panels more exclusive and new, faced to the world of interior design.

GLI AZIONAMENTI

La gamma Nippo adotta due tipologie di azionamento. Azionamento manuale a pannelli liberi: i teli vengono posizionati manualmente e sono sovrapponibili in qualsiasi posizione per tutta la superficie che si intende arredare con il sistema. Azionamento manuale con asta di comando: i teli sono agganciati l'uno all'altro in modo tale che il movimento di uno di essi provochi anche lo spostamento degli altri.

OPERATING

Nippo offers two solutions in terms of actuation. Not-hooked hand drawn panel: the fabric panels are manually placed and are stackable in any position for the entire surface that you desire to decorate with the system. Manual operation with control rod: the curtains are attached to one another in such a way that the movement of one of them also causes the displacement of the other.

LA CURA PER IL DETTAGLIO

Una estrema attenzione all'utilizzo di **materiali pregiati** per evidenziare il valore aggiunto di un prodotto fuori dal coro. Nippo è la sinergia tra estetica e qualità, la massima accuratezza nei dettagli e la tecnologia di chi produce da cinquant'anni sistemi per tende destinati agli specialisti di tutto il mondo.

FOCUSED ON DETAILS

An extreme attention to the use of **fine materials** to highlight the added value of a particular product. Nippo is the result of the synergy between aesthetics and quality, the maximum accuracy in the details and the technology of who has been producing for fifty years systems for curtains intended for specialists from all over the world.

TESSUTI E COLORI

È un sistema applicabile a soffitto o a parete e su cui possono essere utilizzati tessuti della collezione **Tecnica by Mottura**, con le più molteplici caratteristiche tecniche. È disponibile di serie nelle seguenti varianti colori: alluminio satinato e cromato, bianco lucido e nero opaco.

FABRICS AND COLOURS

It is a system suitable for ceiling or wall mounting, on which fabrics from the **Tecnica by Mottura** collection can be used, offering a wide range of technical characteristics. Nippo is available in the following colours: satined or chromed aluminium, glossy white

Futura

Futura è la linea di prodotti Mottura specificatamente rivolta all'**interior design di alta gamma**. Un'interpretazione del prodotto che è la realizzazione della nostra mission "tecnologia e creatività".

Una linea di prodotto, caratterizzata da un design italiano al 100% concepita con estrema attenzione all'aspetto estetico ma affiancata dal valore aggiunto di sempre di Mottura e cioè la capacità di sviluppare prodotti tecnologici di alta qualità le cui prestazioni sono indiscutibili.

Oriente e Nippo sono prodotti presenti in questa gamma di alta qualità e sono offerti in una serie speciale in cui tutti i dettagli sono realizzati in materiali pregiati e con rifiniture di qualità superiore.

Futura is Mottura's product range specifically designed for **high-end interior design**. It embodies our mission of "technology and creativity".

A product line characterised by 100% Italian design, conceived with the utmost attention to aesthetics, yet complemented by Mottura's long-standing added value: the ability to develop high-quality technological products whose performance is unquestionable. Oriente and Nippo are products featured in this high-quality range and are offered in a special series where every detail is crafted from premium materials and finished to the highest standard.

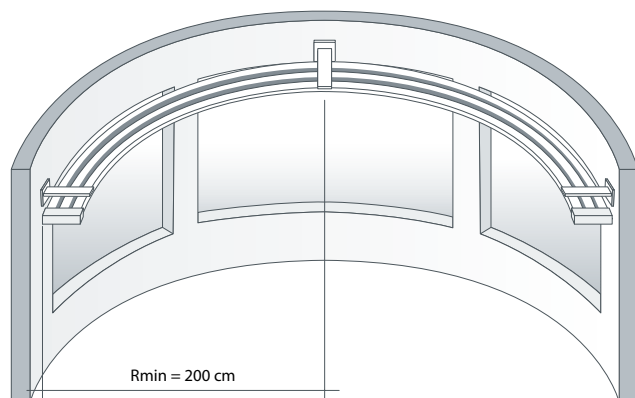
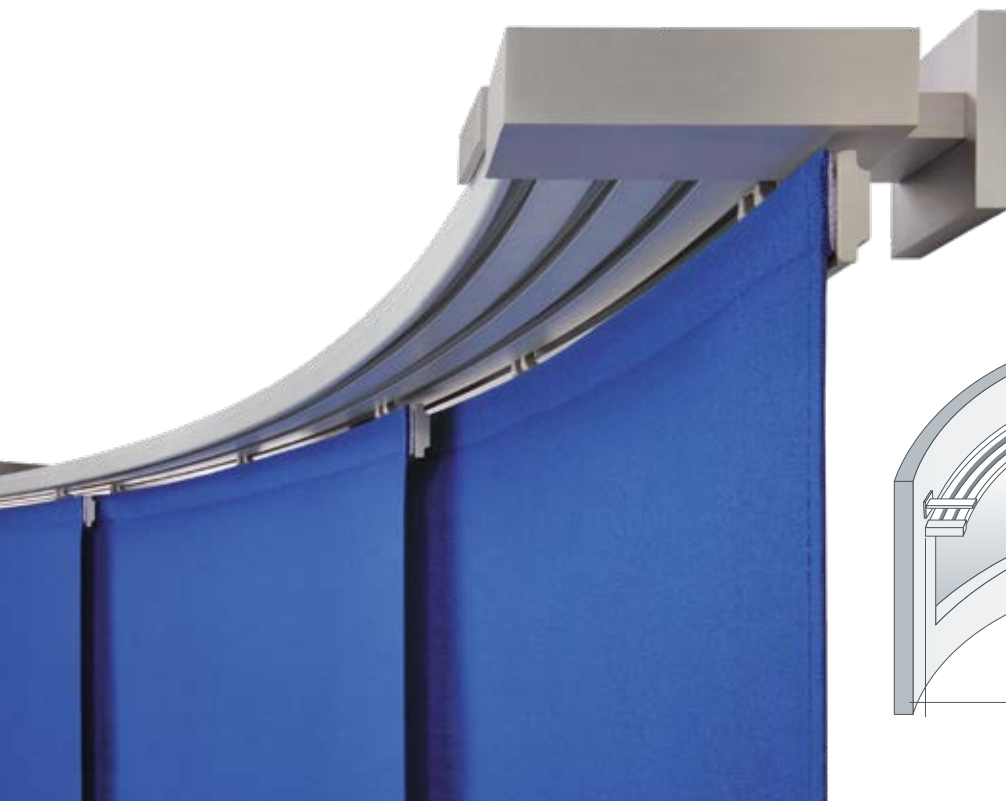

CURVE AD AMPIO RAGGIO

Da sempre la curvabilità è una delle caratteristiche prioritarie dei sistemi per tende in alluminio Mottura ed anche Oriente e Nippo sono sistemi curvabili ad ampio raggio, con raggio minimo di 200 cm. L'azionamento dei sistemi curvi ad ampio raggio può essere manuale ed a motore per Oriente, esclusivamente manuale per Nippo.

LARGE RADIUS BENDS

Curvability has always been one of the key features of Mottura's aluminium systems, and both Oriente and Nippo are wide-radius curved systems, with a minimum radius of 200 cm. The wide-radius curved systems can be operated manually or by motor in the case of Oriente, whilst Nippo is operated exclusively by hand.

Installazioni Installations

INSTALLAZIONE A PARETE WALL INSTALLATION

INSTALLAZIONE A SOFFITTO CEILING INSTALLATION



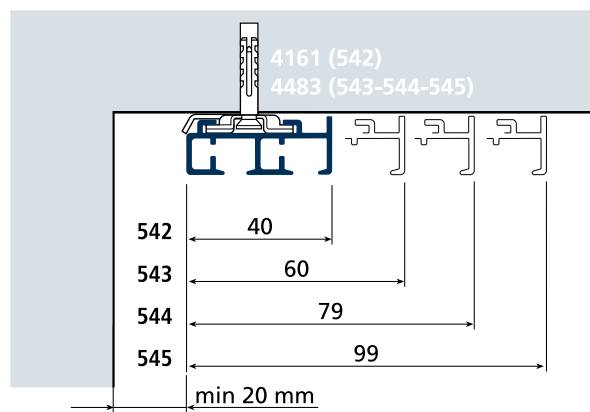
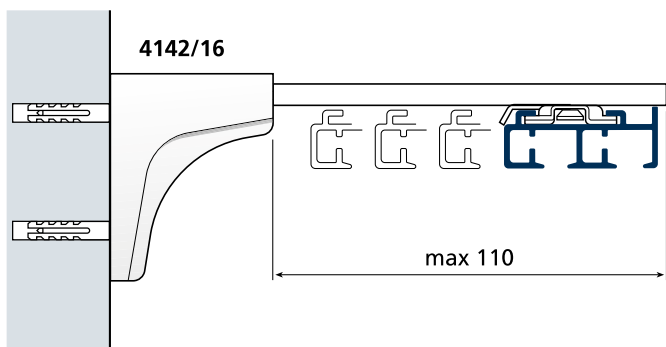



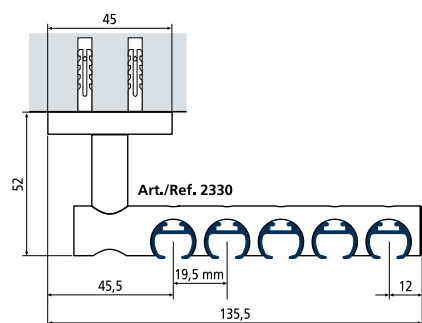
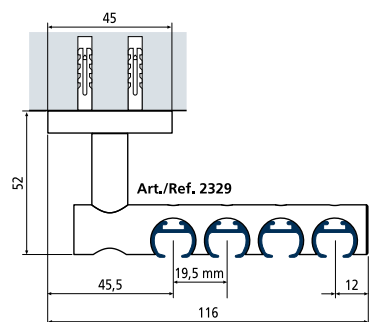
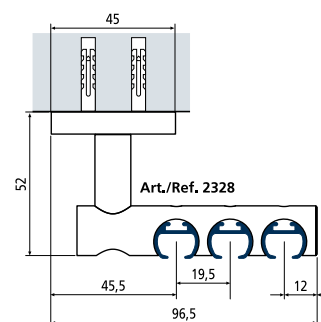
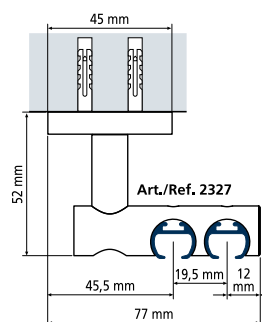
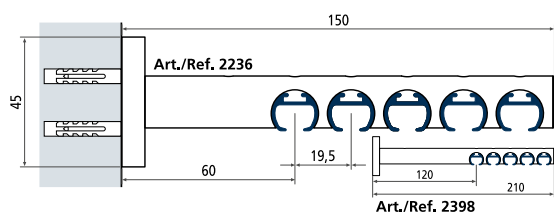
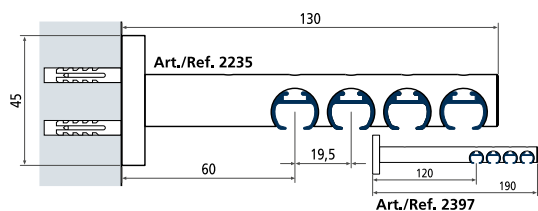
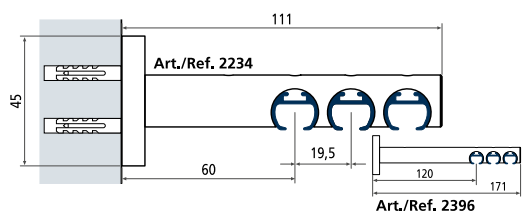
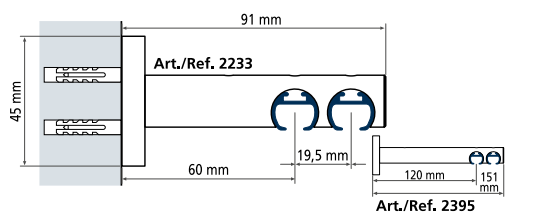



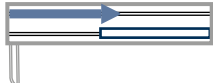
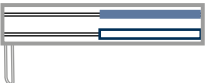

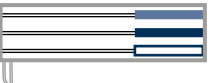
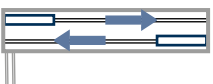

ORIENTE

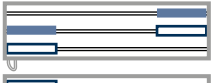
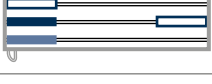
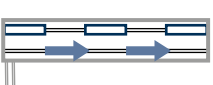
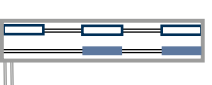
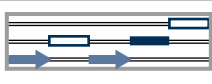
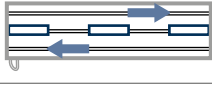
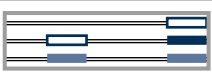

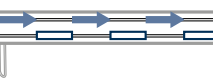
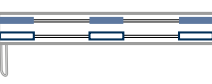
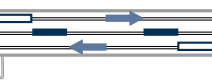
NIPPO

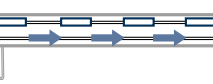

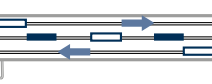
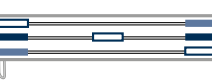
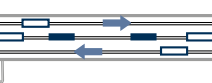
Guida all'utilizzo Directory for use

	Oriente 2 CANALI - WAYS		Oriente 3 CANALI - WAYS	
	CHIUSO / CLOSED	APERTO / OPEN	CHIUSO / CLOSED	APERTO / OPEN
2 teli / panels	 A		-	-
3 teli / panels	-	-	 C	
4 teli / panels	 E		 E  F	 
5 teli / panels	 G		 G  H	 
5 teli / panels 2 azionamenti / operation	-	-	-	-
6 teli / panels	 M		 M	
6 teli / panels 2 azionamenti / operation	-	-	-	-
7 teli / panels	 Q		 Q	
7 teli / panels 2 azionamenti / operation	-	-	-	-
8 teli / panels	-	-	 U	



LEGENDA / LEGEND



PANNELLO FISSO / STATIONARY PANEL



PANNELLO DI COMANDO / CORD-OPERATED PANEL



PANNELLO TRAINATO / DRAWN PANEL



ART. 4211: ARRESTO TENDA / STOP SCREW

SOLO PER PANNELLI GUIDATI CON CORDE O CON ASTA DI MANOVRA

ONLY FOR PANELS MOVED BY CORDS OR BY ROD

COMPONIBILITÀ (6 CANALI) MODULAR DESIGN (6 CHANNELS)

A

543-543







B

544-542

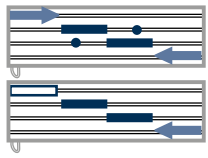
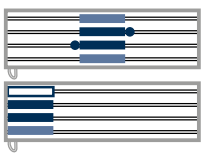
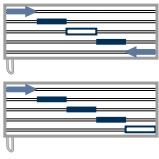
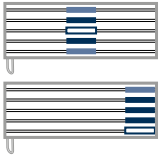
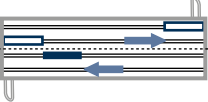
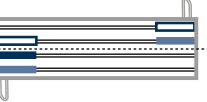
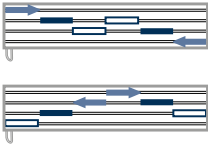
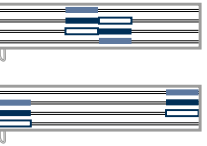
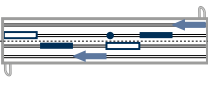
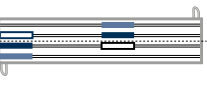
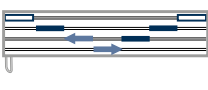

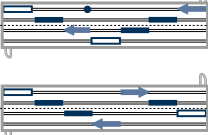
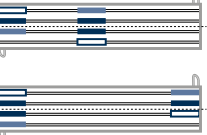
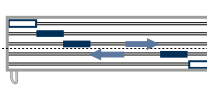
Guida all'utilizzo Directory for use

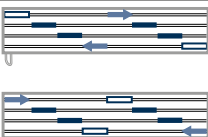
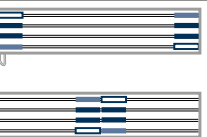
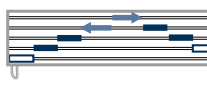
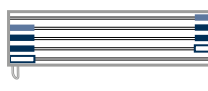
	Oriente 4 CANALI - WAYS		Oriente 5 CANALI - WAYS	
	CHIUSO / CLOSED	APERTO / OPEN	CHIUSO / CLOSED	APERTO / OPEN
2 teli / panels	-	-	-	-
3 teli / panels	-	-	-	-
4 teli / panels	 E F		-	-
5 teli / panels	-	-	 G H	
5 teli / panels 2 azionamenti / operation	 I		-	-
6 teli / panels	 M N		-	-
6 teli / panels 2 azionamenti / operation	 O		-	-
7 teli / panels	 Q		-	-
7 teli / panels 2 azionamenti / operation	 S T		 S	
8 teli / panels	 U V		 U	

AZIONAMENTO A MOTORE Vac MOTOR OPERATING

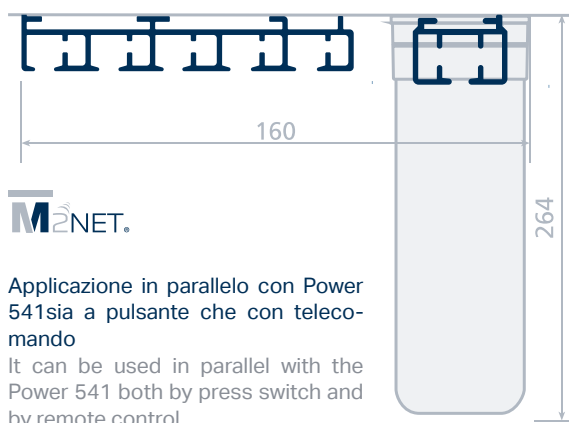

PORTA-TELO CURTAIN PROFILE

Art. 520 - in alluminio, velcrato, di serie (anche nei sistemi curvati) per Oriente e, su richiesta, Nippo / Aluminium system with Velcro both for Oriente and, on demand, Nippo (curved systems too).

Art. 4332 - in PVC, velcrato, su richiesta per Oriente e Nippo con azionamento manuale e motorizzato / PVC system with Velcro on demand for Oriente and Nippo hand drawn, cord or motor operating.







Art. 540 - in alluminio, velcrato, di serie per Nippo e, su richiesta, per Oriente con azionamento manuale ed a corde / Aluminium system with Velcro standard for Nippo, on demand, for Oriente range.

art. 520

art. 4332

art. 540

LA GAMMA / THE RANGE

		AZIONAMENTO OPERATION	INSTALLAZIONE INSTALLATION		CANALI / WAYS			
			SOFFITTO CEILING	PARETE WALL	2	3	4	5
ORIENTE	5400C		•	•	•	•	•	•
	5400ST		•	•	•	•	•	•
	5400VA		•	•	•	•	•	•
	5401C		•	•		•	•	•
	5401ST		•	•	•	•	•	•
	5401VA		•	•	•	•	•	•
NIPPO	6400ST		•	•	•	•	•	•
	6400VA		•	•	•	•	•	•

ORIENTE - COLORI DISPONIBILI - AVAILABLE COLOURS



Alluminio satinato
Satinated aluminium



Alluminio cromato
Chromed aluminium



RAL 9010
Bianco puro
Pure white



RAL 9005
Nero opaco
Matt black

NIPPO - COLORI DISPONIBILI - AVAILABLE COLOURS



Alluminio satinato
Satinated aluminium



Alluminio cromato
Chromed aluminium

