

# Stralys 477

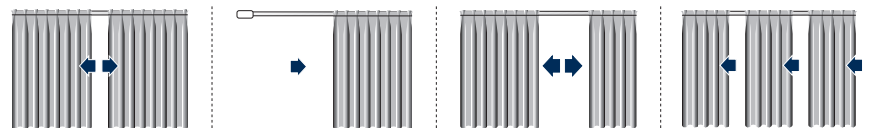

1.1.71







## CARATTERISTICHE TECNICHE - SPECIFICATIONS CARACTERÍSTICAS - CARACTERÍSTICAS - CARACTÉRISTIQUES EIGENSCHAFTEN - KARAKTERISTIEKEN - ХАРАКТЕРИСТИКИ

- Profilo in lega d'alluminio estrusa 6060 T6 UNI 8278 - 100x15 mm
  - Canale di scorrimento: 6 mm
  - Finiture superficiali:  
verniciatura poliester bianco RAL 9016 lucido  
verniciatura poliester nero RAL 9005 opaco; alluminio satinato; vaniglia; tortora; cromato  
altri colori a richiesta
  - Carrucole in termoplas. antiurto verniciato con ruote su perni in acciaio
  - Supporti in alluminio per installazione a parete o in libera sospensione, chiave girevole in metallo per installazione a soffitto
  - Sormonto per tende arricciate 5,5 cm
  - Accessori in acetilica autolubrificante
- Profile in extruded aluminium alloy 6060 T6 UNI 8278 - 100x15 mm
  - Slide track: 6 mm
  - Surface finish:  
RAL 9016 white polyester paint polished;  
RAL 9005 black polyester paint matt; satinated aluminium;  
vanilla, dove grey; chromed  
available on request
  - Painted impact-resistant thermoplastic pulleys with wheels on steel pins
  - Aluminium supports for wall mounting or free suspension, revolving metal key for ceiling mounting
  - 5.5 cm overlap for draped curtains
  - Accessories in self-lubricating Delrin
- Perfil en aleación de aluminio extrudida 6060 T6 UNI 8278 - 100x15 mm
  - Canal de deslizamiento: 6 mm
  - Acabados superficiales:  
pintura poliéster blanca RAL 9016 brillante;  
pintura poliéster negra RAL 9005 mate; aluminio satinado; vainilla; gris paloma; cromado  
otros colores bajo petición
  - Garruchas en material termoplástico antichoque pintado, con ruedas sobre pernos de acero
  - Soportes en aluminio para instalación en pared o en suspensión libre, chaveta giratoria de metal para la instalación en techo
  - Sobreposición de 5,5 cm para cortinas plisadas
  - Accesorios en acetálico autolubrificante
- Perfil de liga de alumínio extrudido 6060 T6 UNI 8278 - 100x15 mm
  - Calha de deslizamento: 6 mm
  - Acabamentos superficiais:  
tinta de poliéster branca RAL 9016 polido  
tinta de poliéster preta RAL 9005 mate; alumínio satinado; baunilha; cinza claro; cromado  
outras cores a pedido
  - Polias de material termoplástico anti-choque pintado com rodas sobre pernos de aço
  - Suportes de alumínio para instalação na parede ou em suspensão livre, chaveta giratória de metal para instalação no tecto
  - Sobreposição para cortinas franzidas 5,5 cm
  - Acessórios de resina acetálica autolubrificante
- Profilé en alliage d'aluminium extrudé 6060 T6 UNI 8278 - 100x15 mm
  - Gorge de coulissement: 6 mm
  - Finition superficielle:  
peinture polyester blanc RAL 9016 brillant;  
peinture polyester noir RAL 9005 mat;  
aluminium satiné; vanille; gris tourterelle; chromé  
autres couleurs sur demande
  - Poulies en matériau thermoplastique antichoc peint, avec roulettes sur axe en acier
  - Supports en aluminium pour installation murale ou à suspension libre, clavette rotative en métal pour installation au plafond
  - Chevauchement pour rideaux francés 5,5 cm
  - Accessoires en résine d'acétyle autolubrifiante
- Rohrwelle aus stranggepresster Aluminiumlegierung 6060 T6 UNI 8278 100x15 mm - Laufkanal: 6 mm
  - Oberflächen-Finish:  
Polyesterlackierung Weiß RAL 9016 poliert;  
Polyesterlackierung Schwarz RAL 9005 matt;

Alu eloxiert; Vanille; Taubengrau; verchromt  
andere Farben auf Anfrage

- Laufrollen aus lackiertem stoßfestem Thermoplast mit auf Stahlstiften laufenden Rollen
  - Aluminiumhalterungen für die Wandmontage oder freihäng ende Montage, Drehkeil aus Metall für die Deckenmontage
  - Überlappung für Vorhänge 5,5 cm
  - Zubehör aus selbstgleitendem Acetal
- Profiel van geëxtrudeerde aluminiumlegering 6060 T6 UNI 8278 100x15 mm - Loopkanaal: 6 mm
  - Oppervlakteafwerking: RAL 9016 wit polyester lak gepolijst RAL 9005 zwart polyester lak mat zilver geanodiseerd; vanille; duifgrijs; verchromd andere kleuren op aanvraag
  - Katrollen van gelakt stootbestendig thermoplast met wielen op stalen pennen
  - Aluminium steunen voor installatie op wand of vrije ophanging, draaibare metalen bevestigingsspie voor installatie op wand
  - Overlappingsprofiel voor plooi gordijnen 5,5 cm
  - Accessoires van zelfsmarend acetal
- Профиль из экструдированного алюминиевого сплава 6060 T6 UNI 8278 - 100x15 мм - Желоб: 6 мм
  - Специальная отделка:  
полиэфирная окраска в белый цвет RAL 9016 полированный;  
полиэфирная окраска в черный цвет RAL 9005 матовый;  
сатинированный алюминий; ваниль; хром; серо-коричневый другие цвета — по запросу
  - Шкивы из противоударного, окрашенного термопласта с колесами на стальных осях
  - Алюминиевые суппорты для настенного или свободного подвешивания, поворотный металлический ключ для потолочной установки
  - Налагающий кронштейн для складчатых штор 5,5 см.
  - Принадлежности из самосмазывающейся ацеталовой пластмассы

## ARRESTO MAGNETICO

MAGNETIC STOP  
TOPE MAGNÉTICO  
SISTEMA MAGNÉTICO DE PARAGEM  
BUTÉE MAGNÉTIQUE  
MAGNETARRETIERUNG  
MAGNETISCHE AANSLAG  
МАГНИТНЫЙ СТОПОР

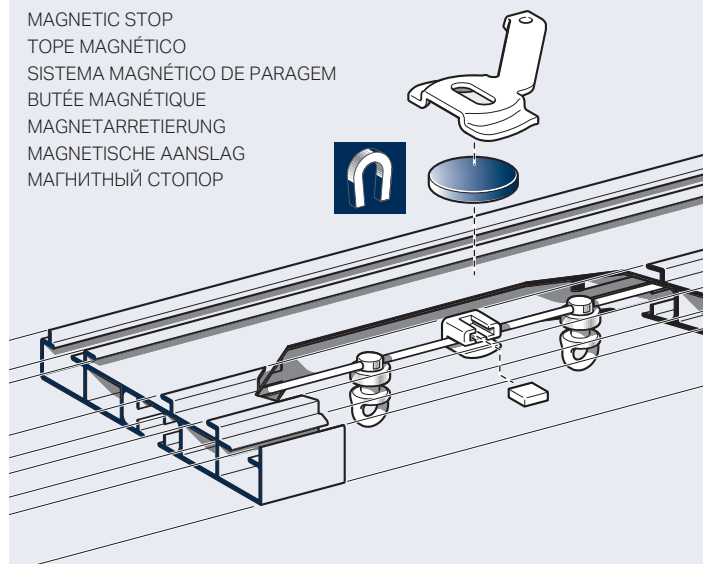

- L'utilizzo dell'art. 4603 permette di determinare il punto di arresto del telo (strappo)
- Art. 4603 can be used to fix the curtain stop point (hand draw system)
- El uso del art. 4603 permite establecer el punto de parada de la tela (tirón)
- A utilização do art. 4603 permite determinar o ponto de paragem da cortina (acionamento à mão)
- L'utilisation de l'art. 4603 permet de déterminer le point d'arrêt du rideau (à la main)
- Die Verwendung von Art. 4603 gestattet die Festlegung des Arretierungspunktes der Stoffbahn (Schleuderzug)
- Het gebruik van art. 4603 staat toe om het aanslagpunt van het doek te bepalen (handmatig)
- Использование арт. 4603 позволяет определить точку остановки полотнища (ручная версия)



1.1.74

# Stralys 477

## INSTALLAZIONE

INSTALLATION  
INSTALACIÓN  
INSTALAÇÃO  
INSTALLATION  
INSTALLATIE  
УСТАНОВКА

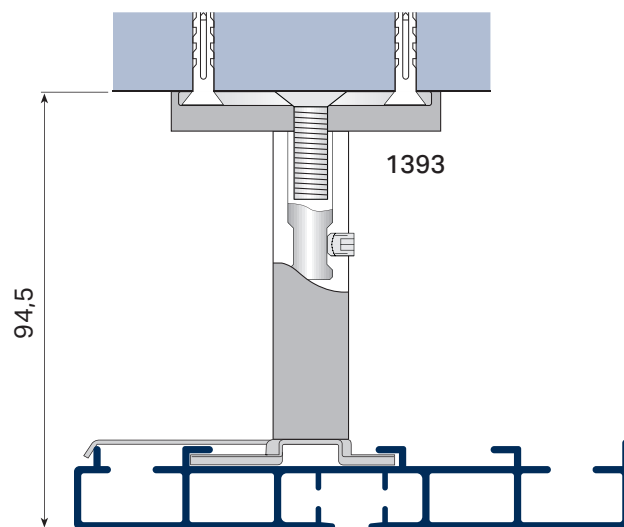
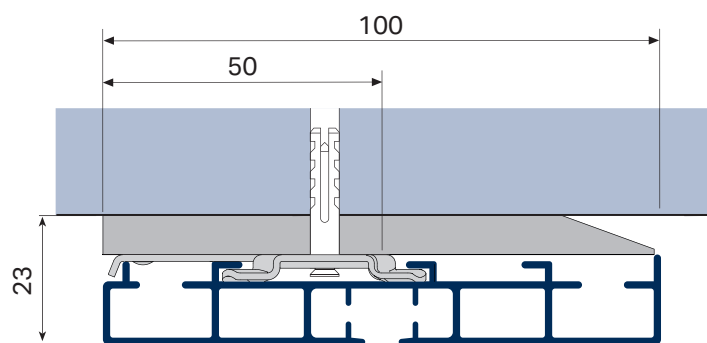
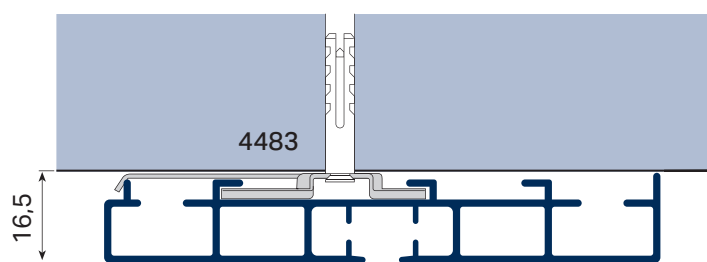
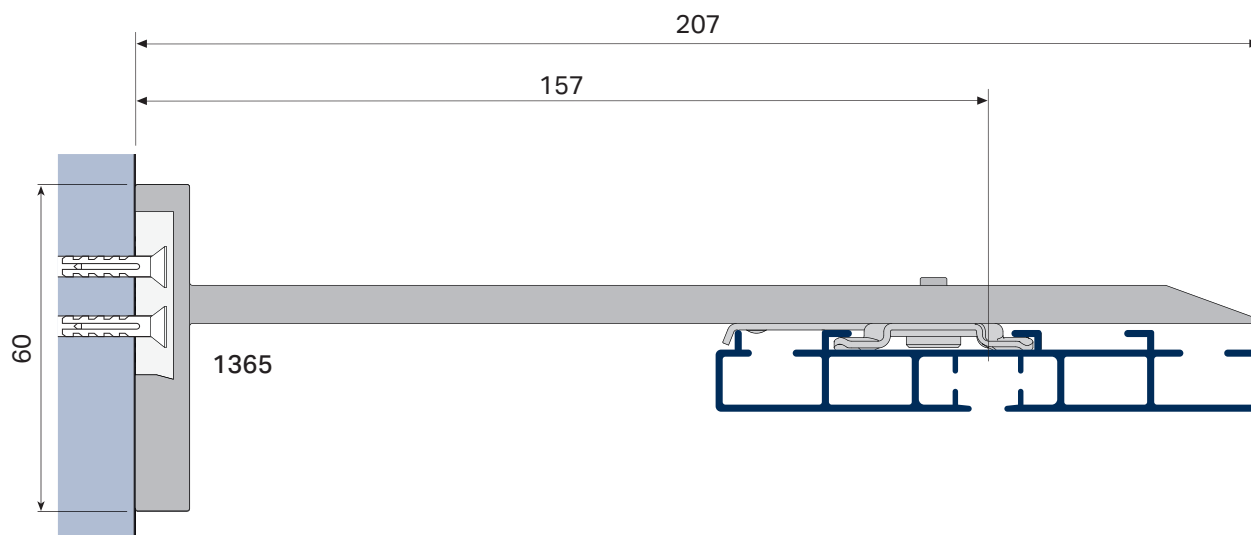
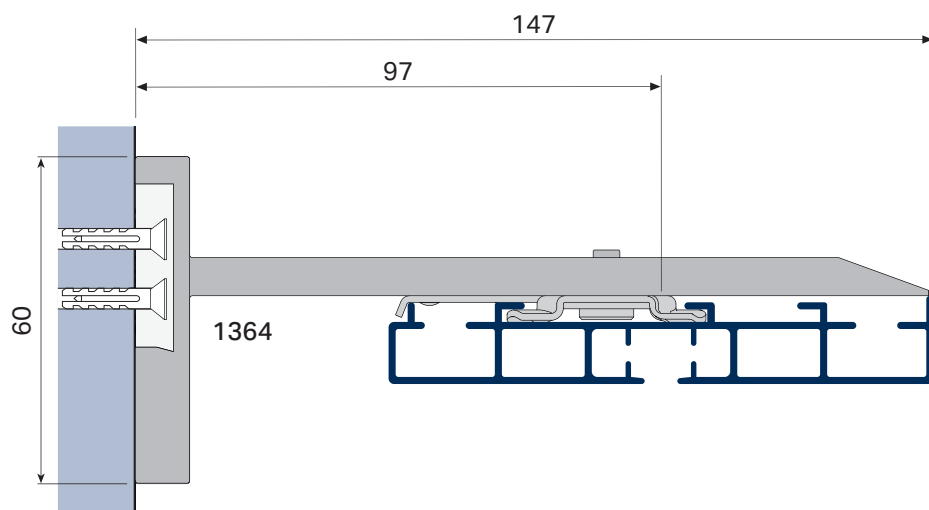

1397

ARRICCIATURA - DRAPING - FRUNCIDO - FRANZIDO  
FRONCES - KRÄUSELUNG - PLOOIING - СКЛАДЧАТОСТЬ



\* VALORI INDICATIVI - APPROXIMATE VALUE - VALOR APROXIMADO • L'arricciatura continua della tenda è realizzata per mezzo di una corda distanziatrice all'interno del canale di scorrimento degli scivoli  
VALOR APROXIMADO - VALOR APROXIMADO - VALEUR APPROXIMATIVE - UNGEFÄHRER WERT BENADERENDE WAARDE - ПРИБЛИЖЕННОЕ ЗНАЧЕНИЕ

SPAZIATURA SCIVOLI - SLIDER SPACING SEPARACIÓN DESLIZADERAS - DIST. ENTRE OS RODÍZIOS ESPAC. DES GLISSEURS - GLEITABSTAND SPATIERUNG RUNNERS - РАСПРЕДЕЛЕНИЕ ПОЛОЗКОВ	SPAZIATURAGANCI-HOOKSPACING SEPARACIÓN GANCHOS - DIST. ENTRE OS GANCHOES PAC. DESCROCHETS - HAKENABSTAND SPATIERUNG HAKEN - РАСПРЕДЕЛЕНИЕ КРЮЧКОВ	A
		≈ 1:1,7*
		≈ 1:2*
		≈ 1:1,75*
		≈ 1:2*

- Continuous curtain draping is achieved by means of a spacer cord inside the channel along which the sliders run.
- El fruncido continuo de la cortina se obtiene mediante una cuerda distanciadora presente en el interior del canal de deslizamiento de las deslizaderas
- O efeito franzido contínuo da cortina é feito por meio de um cordão espaçador dentro da calha de deslizamento dos rodízios.
- Les fronces continues du rideau sont réalisées par le biais d'un cordon d'écartement à l'intérieur de la gorge de déplacement des coulisseaux
- Die durchgängige Kräuselung erfolgt mittels einer Distanzschur im Laufkanal der Gleiter
- De continue plooiing van het gordijn wordt gerealiseerd met behulp van een afstandskoord in het loopkanaal van de runners
- Постоянная складчатость шторы обеспечивается распределительным шнуром внутри желоба скользящих полозков

CONFEZIONI - STYLES OF CURTAINS - TIPOS DE CONFECCIÓN - TIPOS DE CORTINAS  
CONFECTION CONSEILLÉE - VORHANGBÄNDER - AANBEVOLEN CONFECTIE - МОДЕЛЬ

	A	B
	≈ 1:1,7 - 1:2	art. 799 - h 75 mm
	≈ 1:1,75 - 1:2	art. 799 - h 75 mm
	1:2	art. 768 - h 30 mm art. 738 - h 65 mm
	1:2	art. 768 - h 30 mm art. 738 - h 65 mm
	1:2	art. 768 - h 30 mm art. 738 - h 65 mm

A

RAPPORTODIARRICCIATURA-SPACEBETWEEN THE PLEATS-RAPPORT DEFRUNCIDO-RELAÇÃO DEFRANZIDO-DISTANCIAMENTO ENTRE PLEIS-GIBT DEN RAFFRAPPORT AN-GEEFT DE AFSTAND TUSSEN DE PLOOIEN AAN-ВИД ДРАПИРОВКИ

B

NASTRO - TAPE - CINTA - FITA - GALON - BAND - LINT - ЛЕНТА



MISURE CONSIGLIATE - MESURES RECOMMANDÉES - EMPFOHLENE MASSNAHMEN - RECOMMENDED MEASURES  
 MEDIDAS RECOMENDADAS - MEDIDAS RECOMENDADAS - AANBEVOLEN MAATREGELLEN - РЕКОМЕНДУЕМЫЕ РАЗМЕРЫ

APERTURA LATERALE - LATERAL OPENING - APERTURA LATERAL - ABERTURA LATERAL - OUVERTURE LATERAL - EINTEILIG - LATERAAL - БОКОБОЕ

APERTURA CENTRALE - CENTRAL OPENING - APERTURA CENTRAL - ABERTURA CENTRAL - OUVERTURE CENTRAL - 2-TEILIG - CENTRAAL - ЦЕНТРАЛЬНОЕ

APERTURA LATERALE - LATERAL OPENING - APERTURA LATERAL - ABERTURA LATERAL - OUVERTURE LATERAL - EINTEILIG - LATERAAL - БОКОБОЕ

APERTURA CENTRALE - CENTRAL OPENING - APERTURA CENTRAL - ABERTURA CENTRAL - OUVERTURE CENTRAL - 2-TEILIG - CENTRAAL - ЦЕНТРАЛЬНОЕ

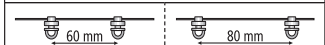
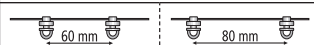
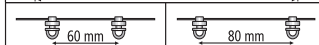
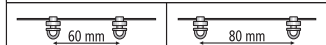
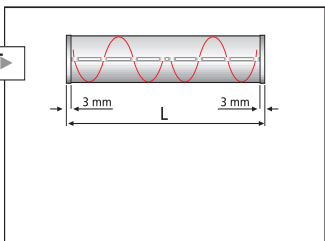
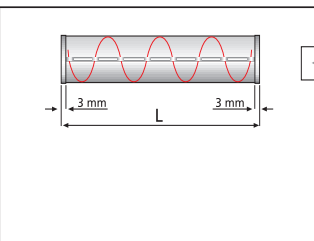
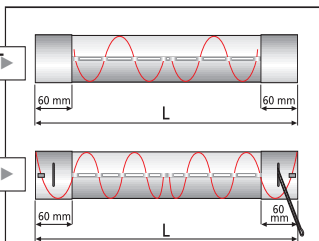
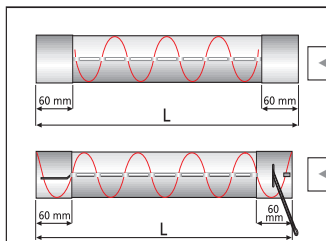

477 ST1 (*)	477 C1 (*)	477 ST2 (*)	477 C2 (*)
L cm	pz	L cm	pz
54	8	46	58
66	10	58	74
78	12	70	90
90	14	82	106
102	16	94	122
113	18	105	137
125	20	117	153
137	22	129	169
148	24	141	185
161	26	153	201
172	28	164	216
184	30	176	232
196	32	188	248
208	34	200	264
220	36	212	280
231	38	223	295
243	40	235	311
255	42	247	327
267	44	259	343
279	46	271	359
290	48	283	374
302	50	295	390
314	52	306	406
326	54	319	422
338	56	331	438
349	58	342	453
361	60	353	469
373	62	365	485
386	64	377	501
398	66	389	517
408	68	400	533
421	70	412	549
433	72	424	565
445	74	437	581
457	76	449	597
468	78	460	
480	80	472	
492	82	484	
504	84	496	
516	86	508	
527	88	519	
539	90	531	
551	92	543	
563	94	555	
575	96	567	
586	98	578	
598	100	590	
610	102	604	

477 ST1 (*)	477 C1 (*)	477 ST2 (*)	477 C2 (*)
L cm	pz	L cm	pz
47	8	30	47
71	12	59	67
94	16	83	101
118	20	105	143
142	24	129	175
165	28	153	206
189	32	176	238
213	36	200	270
236	40	224	301
259	44	247	333
283	48	269	364
307	52	294	396
330	56	317	429
354	60	341	460
377	64	365	492
401	68	380	523
425	72	412	555
449	76	436	587
472	80	460	
496	84	484	
519	88	507	
543	92	531	
567	96	555	
590	100	567	

477 ST1 (*)	477 ST2 (*)
L cm	pz
44	8
57	10
68	12
80	14
92	16
104	18
116	20
128	22
140	24
151	26
163	28
175	30
188	32
199	34
211	36
222	38
234	40
246	42
258	44
270	46
281	48
293	50
305	52
317	54
329	56
341	58
352	60
364	62
375	64
387	66
399	68
411	70
422	72
434	74
446	76
458	78
470	80
482	82
493	84
505	86
517	88
529	90
540	92
552	94
564	96
576	98
588	100
600	102

477 ST1 (*)	477 ST2 (*)
L cm	pz
37	8
61	12
85	16
108	20
132	24
156	28
179	32
203	36
226	40
250	44
274	48
298	52
322	56
346	60
370	64
393	68
417	72
441	76
464	80
486	84
512	88
536	92
560	96
584	100
596	102

