

# Rollbox 240

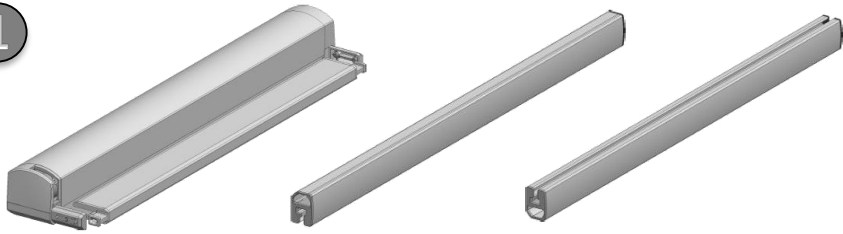

Z401 Foglio istruzioni Rollbox 240

1



2

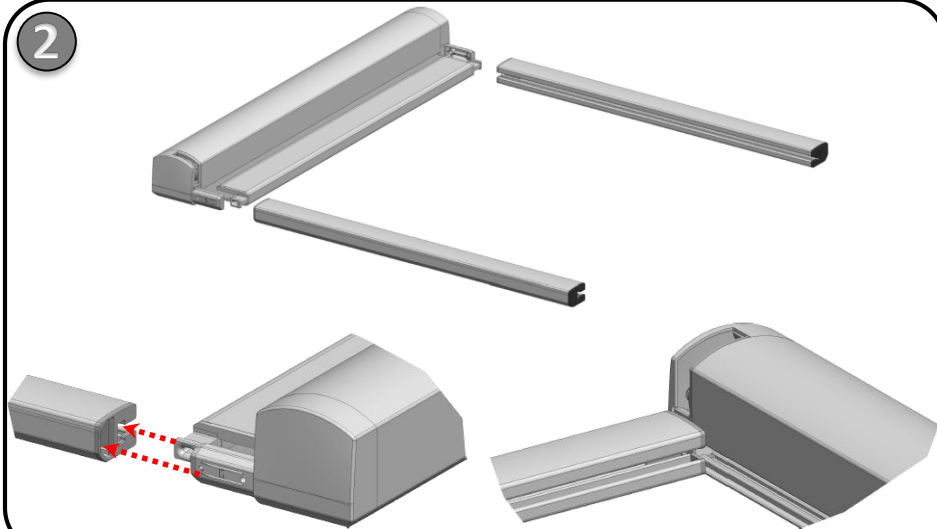

3

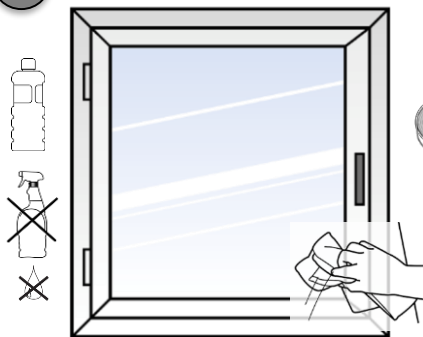

4

Ref. 4633N

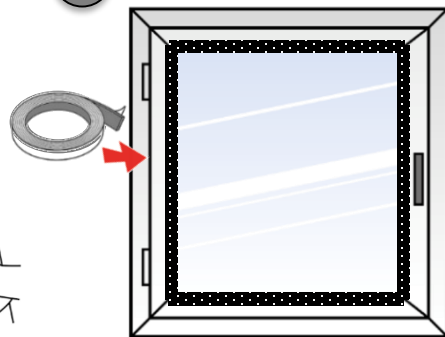

# Rollbox 240



Z401 Foglio istruzioni Rollbox 240

5a

Ref. 4632B

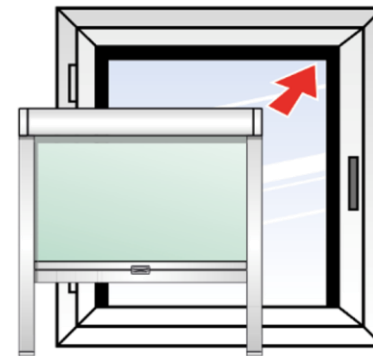
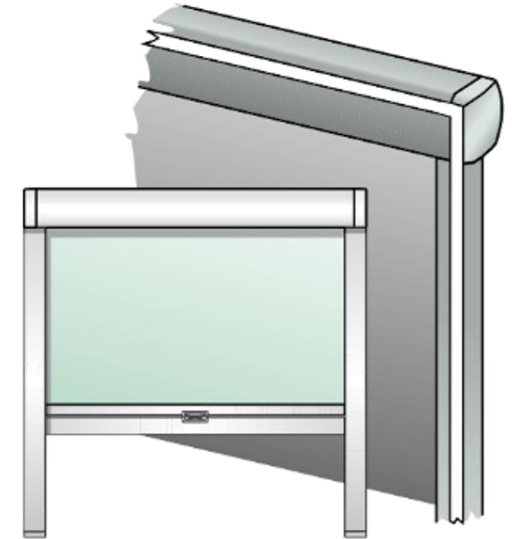
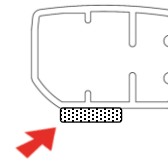
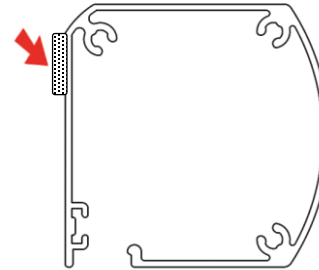
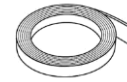

# Rollbox 240



Z401 Foglio istruzioni Rollbox 240

5b

Ref. 4617N

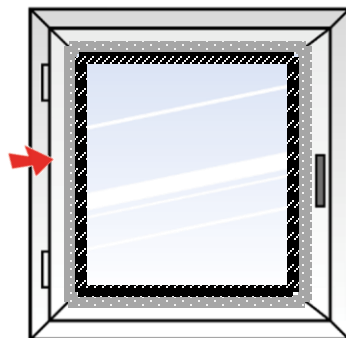
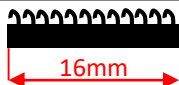

6b

Ref. 4617N

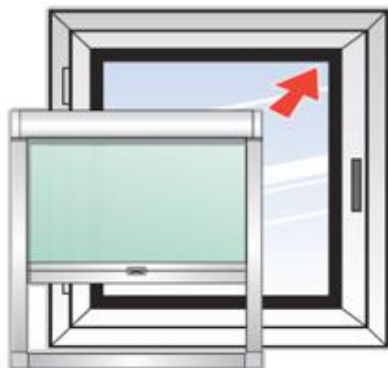
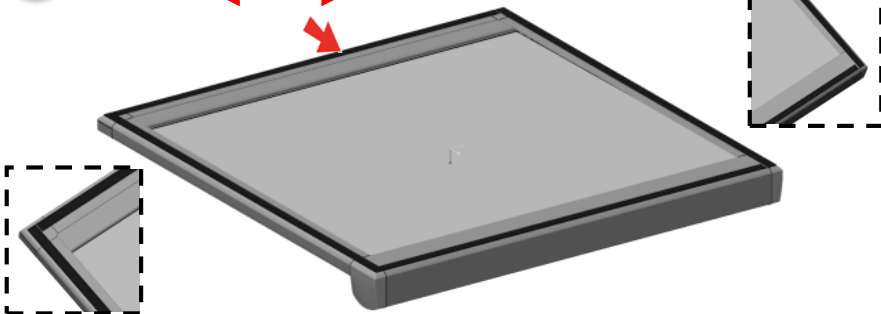
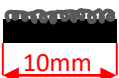

# Rollbox 240



Z401 Foglio istruzioni Rollbox 240

MOTTURA S.p.A.

Via XXV Luglio, 1

10090 - San Giusto Canavese (To) Italia

Tel. (0039) 0124.49.49.4

Fax (0039) 0124.49.49.18

Internet: [www.mottura.com](http://www.mottura.com)

E-mail: [mottura@mottura.com](mailto:mottura@mottura.com)