

Plix 353



9.1.27





9.1.28

Plìx 353

1:1

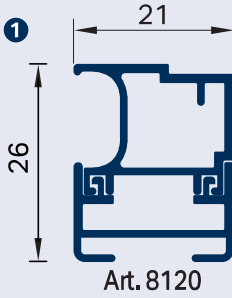

Art. 8120

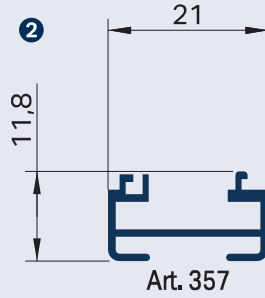

Art. 357

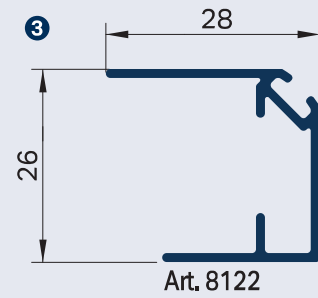

Art. 8122

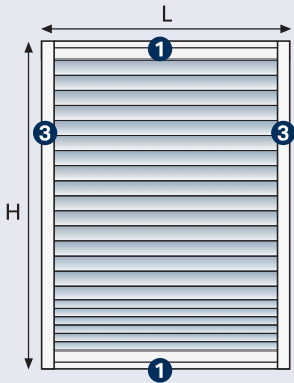

L max: 150 cm
H max: 250 cm

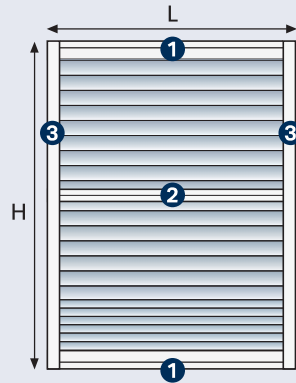

L max: 150 cm
H max: 250 cm

USE

UTILIZZO - USE - USO
USO - UTILISATION - ANWENDUNG
GEBRUIK - ИСПОЛЬЗОВАНИЕ

SISTEMA MULTISTOP PER TENDE PLISSETTATE 20 mm

Utilizzo per tessuti plissè e cellulari 20 mm
Indicato per installazioni domestiche e professionali.
Scorrimento verticale, orizzontale o inclinato.
Indicato per tende filtranti e oscuranti max 150x250 cm.
Azionamento manuale con arresto in qualsiasi posizione.
Disponibile con tessuto singolo o doppio.
L'installazione è su vetro con fissaggio adesivo o velcro.

MULTISTOP PLEATED BLIND SYSTEM 20 mm

Used for pleated/cellular fabric 20 mm
Suitable for domestic and professional installations.
Vertical, horizontal or inclined scrolling.
Suitable for filtering and blackout fabrics 150x250 cm max.
Manual operating with stop in any position.
Available with single or double fabrics.
Installation is on glass, with adhesive fixing.

SISTEMA MULTISTOP DE CORTINAS PLISADAS 20 mm

Uso para tejidos plisados y celulares 20 mm
Indicado para instalaciones domésticas y profesionales.
Deslizamiento vertical horizontal o inclinado.
Indicado para cortinas filtrantes y opacas máx. 150x250 cm.
Funcionamiento manual con la parada en cualquier posición.
Disponibile con los tejidos simples o dobles.
La instalación es sobre vidrio con adhesivo o velcro.

SISTEMA MULTISTOP PARA CORTINAS PLISSADAS 20 mm

IUso para tecidos plissados e celulares de 20 mm

Indicado para instalações domésticas e profissionais.
Deslizamento vertical, horizontal ou inclinado.
Indicado para cortinas filtrantes e de escurecimento máx 150x250 cm.
Funcionamento manual com batente em alguma posição.
Disponível com únicas ou telas dobro.
A instalação é em vidro com fixação adesiva ou velcro.

SYSTÈME MULTISTOP POUR STORES PLISSÉS 20 mm

Utilisation pour tissus plissés et alvéolaires 20 mm
Conseillé pour locaux domestiques et professionnels.
Coulissement vertical, horizontal ou incliné.
Indiqué pour stores filtrants et occultants max 150x250 cm.
Actionnement manuel avec arrêt en toute position.
Disponible avec tissus simples ou doubles.
Installation sur vitre, avec fixation adhésive ou velcro.

MULTISTOP PLISSEE 20 mm

Verwendung für Plissee- und Zellstoffgewebe 20 mm
Für den privaten Haushalt und den Arbeitsbereich.
Vertikale, horizontales oder schräge Führung.
Für halbtransparente und Verdunkelte Plissee geeignet max. 150x250 cm.
Manuelle Bedienung mit Halt in irgendeiner Position.
Verfügbar mit einfachen oder doppelten Geweben.
Die Montage erfolgt auf Glas mit Klebe- oder Klettverschluss.

MULTISTOP PLISSÉSYSTEEM 20 mm

Gebruik voor plissé- en cellular stoffen 20 mm
Voor privaat en professioneel gebruik.
Toepassing voor verticale, horizontaal en schuine ramen.
Gebruik met verduisterende en filterende stoffen max. 150x250 cm.
Handbediend met eindstop in elke positie.
Beschikbaar met enkele of dubbele stoffen.
Installatie op glas met lijm- of velcro.

СИСТЕМА ДЛЯ ФЛИСИРОВАННЫХ ШТОРОВ 20 мм

Система для плиссированных штор со складками 20 мм.
Предназначена для установки в жилых и офисных помещениях.
Вертикальная, горизонтальная или наклонная прокрутка.
Подходит для фильтрующих и затемняющих штор макс 150x250 см.
Ручной привод с стопом в любом положении.
Доступно с одиночными или двойными тканями.
Монтаж на оконную раму без сверления, с клеевым креплением.



CARATTERISTICHE TECNICHE - SPECIFICATIONS CARACTERÍSTICAS - CARACTERÍSTICAS - CARACTÉRISTIQUES EIGENSCHAFTEN - KARAKTERISTIEKEN - ХАРАКТЕРИСТИКИ

- Profilo superiore ed inferiore e guida laterale in lega d'alluminio estrusa 6060 T6-UNI 8278
 - Profilo superiore Larghezza 21 mm, Altezza 19 mm
 - Profilo inferiore Larghezza 21 mm, Altezza 19 mm
 - Guida laterale Larghezza 28 mm, Profondità 26 mm
 - Profilo porta tessuto in PVC estruso
 - Finitura superficiale:
verniciatura poliesteri bianco RAL 9010 - nero opaco RAL 9005 / anodizzato argento - bronzo
altri colori a richiesta
 - Arresto in poliammide antiusura
- Upper and lower profile and side guide in extruded aluminum alloy 6060 T6-UNI 8278
 - Upper track: Width 21 mm; Height 19 mm
 - Lower track: Width 21 mm; Height 19 mm
 - Side guide Width 28 mm; Height 26 mm
 - Extruded PVC fabric holder track
 - Surface finish: RAL 9010 white - RAL 9005 black / silver anodised - bronze
available on request
 - Wearproof polyamide stop
- Perfil superior e inferior y guía lateral en aleación de aluminio extruido 6060 T6-UNI 8278
 - Perfil superior: Anchura 21 mm - Altura 19 mm
 - Perfil inferior: Anchura 21 mm - Altura 19 mm
 - Guía lateral Ancho 28 mm Profundidad 26 mm
 - Perfil portatejido en PVC extruido
 - Acabados de la superficie:
pintura poliéster blanca RAL 9010 - negra RAL 9005 / Anodizado plata, bronce
otros colores bajo petición
 - Freno de poliamida antiroce
- Perfis superior, inferior e guia lateral em liga de alumínio extrudido 6060 T6-UNI 8278
 - Perfis superior: Largura 21 mm; Altura 19 mm
 - Perfis inferior: Largura 21 mm; Altura 19 mm
 - Guia lateral Largura 28 mm Profundidade 26 mm
 - Perfil porta-tecido em PVC extrudido
 - Acabamento superficial:
tinta de poliéster branca RAL 9010 - preta RAL 9005 / Anodizado prateado, bronze
outras cores a pedido
 - Batente de paragem de poliamida anti-desgaste
 - Profil supérieur et inférieur et guide latéral en alliage d'aluminium extrudé 6060 T6-UNI 8278
 - Profil supérieur: Largeur 21 mm; Hauteur 19 mm
 - Profil inférieur: Largeur 21 mm; Hauteur 19 mm
 - Guide latéral Largeur 28 mm Profondeur 26 mm
 - Profil porte-tissu en PVC extrudé
 - Finition superficielle:
- peinture polyester blanc RAL 9010 - noir RAL 9005 / Anodisé argent, bronze
autres couleurs sur demande
 - Arrêt en polyamide anti-usure
- Oberes und unteres Profil und Seitenführung aus stranggepresster Aluminiumlegierung 6060 T6-UNI 8278
 - Oberes Profil: Breite 21 mm; Höhe 19 mm
 - Unteres Profil: Breite 21 mm; Höhe 19 mm
 - Seitenführung Breite 28 mm Tiefe 26 mm
 - Stoffhalteprofil aus extrudiertem PVC
 - Oberflächen-Finish:
Polyesterlackierung Weiß RAL 9010 - Schwarz RAL 9005 / Alu eloxiert, Bronze
andere Farben auf Anfrage
 - Arretierung aus stoßfestem Polyamid
- Boven- en onderprofiel en zijgeleiding in geëxtrudeerde aluminiumlegering 6060 T6-UNI 8278
 - Bovenprofiel: Breedte 21 mm - hoogte 19 mm
 - Onderprofiel: Breedte 21 mm - hoogte 19 mm
 - Zijgeleiding Breedte 28 mm Diepte 26 mm
 - PVC profiel voor de bevestiging van de stof
 - Oppervlaktebehandeling RAL 9010 wit - 9005 zwart / zilver en brons geanodiseerd
andere kleuren op aanvraag
 - Polyamide eindstop
- Верхний и нижний профиль и боковая направляющая из экструдированного алюминиевого сплава 6060 T6-UNI 8278
 - Ширина верхнего профиля 21 мм; Высота 19 мм
 - Ширина нижнего профиля 21 мм; Высота 19 мм
 - Боковая направляющая Ширина 28 мм Глубина 26 мм
 - Несущий штору профиль из экструдированного ПВХ
 - Отделка поверхности:
полиэфирная окраска в белый цвет RAL 9010 – черный цвет RAL 9005 / Анодирование серебро - бронза
другие цвета — по запросу
 - Блокатор корда из износостойкого полиамида



9.1.30

Plix 353

VERSIONI - VERSIONS - VERSIÓNES - VERSÕES - VERSIONS - SONDERAUSFÜHRUNGEN - VERSIES - ВЕРСИИ

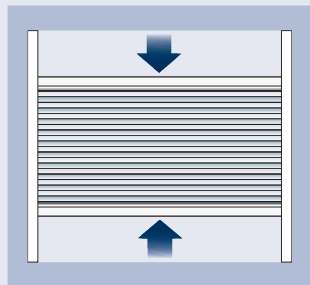

Versione A / A version

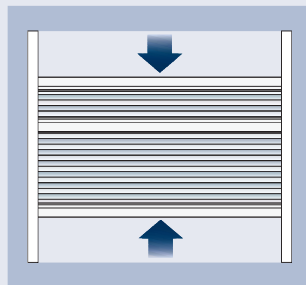

Versione B / B version

APERTURA - OPENING - APERTURA - ABERTURA - OUVERTURE - AUFZUG - OPENEN - ОТКРЫТИЕ

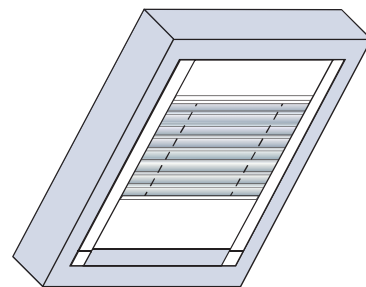
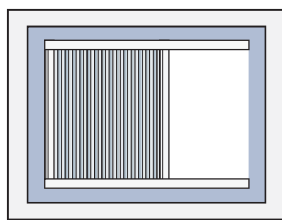
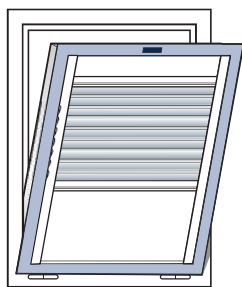
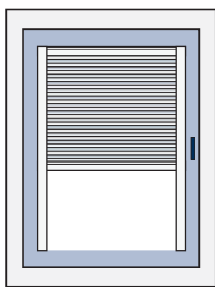

INGOMBRI - OVERALL DIMENSIONS - ESPESORES - DIMENSÃO - ENCOMBREMENT - RAUMBEDARF - ПАКЕТ - ГАБАРИТЫ

INSTALLAZIONE - INSTALLATION - INSTALACIÓN - INSTALAÇÃO - INSTALLATION - INSTALLATION - INSTALLATIE - УСТАНОВКА

A

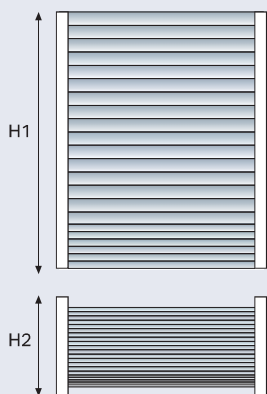

B

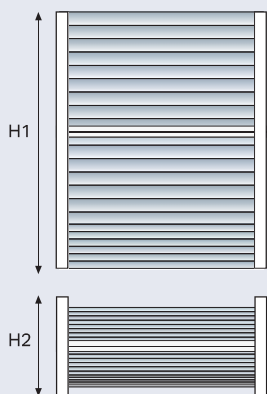

A

L min 15 cm

H1		H2
50 cm	≈	5 cm
100 cm	≈	6 cm
150 cm	≈	7 cm
200 cm	≈	8 cm
250 cm	≈	9 cm

B

L min 15 cm

H1		H2
50 cm	≈	9 cm
100 cm	≈	11 cm
150 cm	≈	13 cm
200 cm	≈	15 cm
250 cm	≈	17 cm



INSTALLAZIONE - INSTALLATION - INSTALACIÓN - INSTALAÇÃO - INSTALLATION - INSTALLATION - INSTALLATIE - УСТАНОВКА

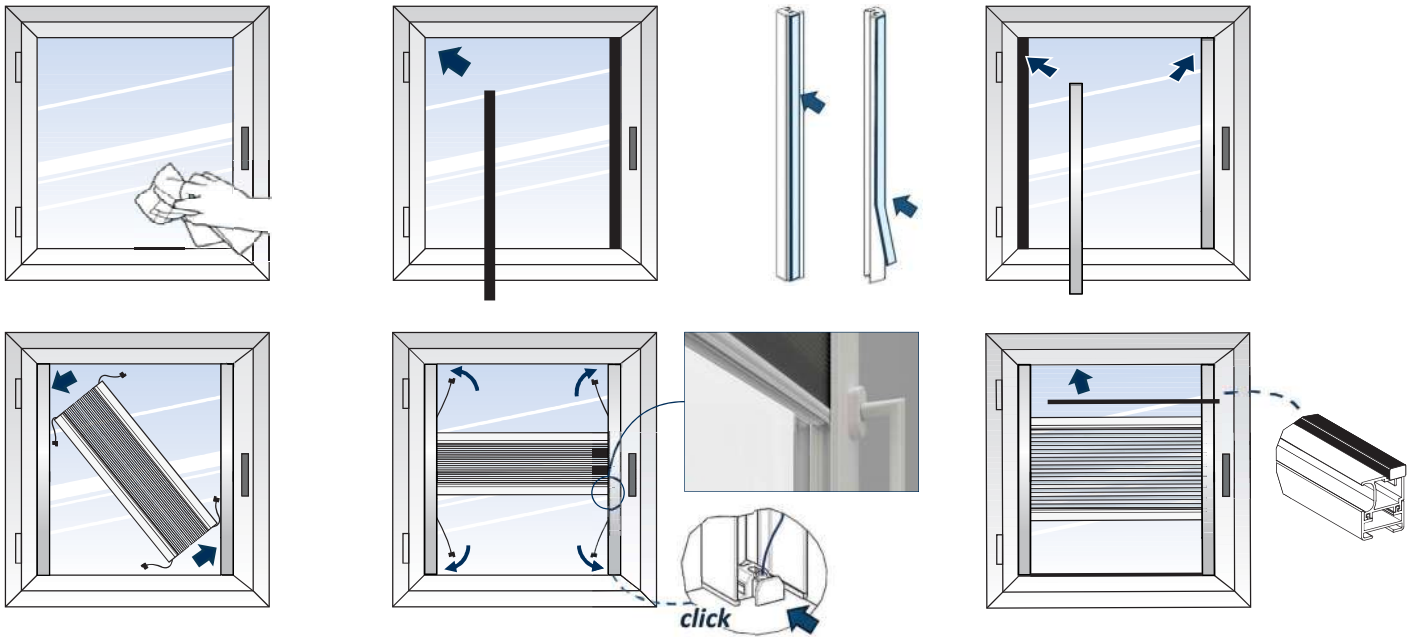

RILIEVO MISURE - MEASUREMENT SURVEY - COMO CALCULAR LAS MEDIDAS - LEVANTAMENTO DAS MEDIDAS - PRISE DES DIMENSIONS - BEMASSUNGEN - NEMEN VAN MATEN - ОБЗОР ПАЗМЕРОВ

Guarnizione / Sealing Max 2 x 2 mm

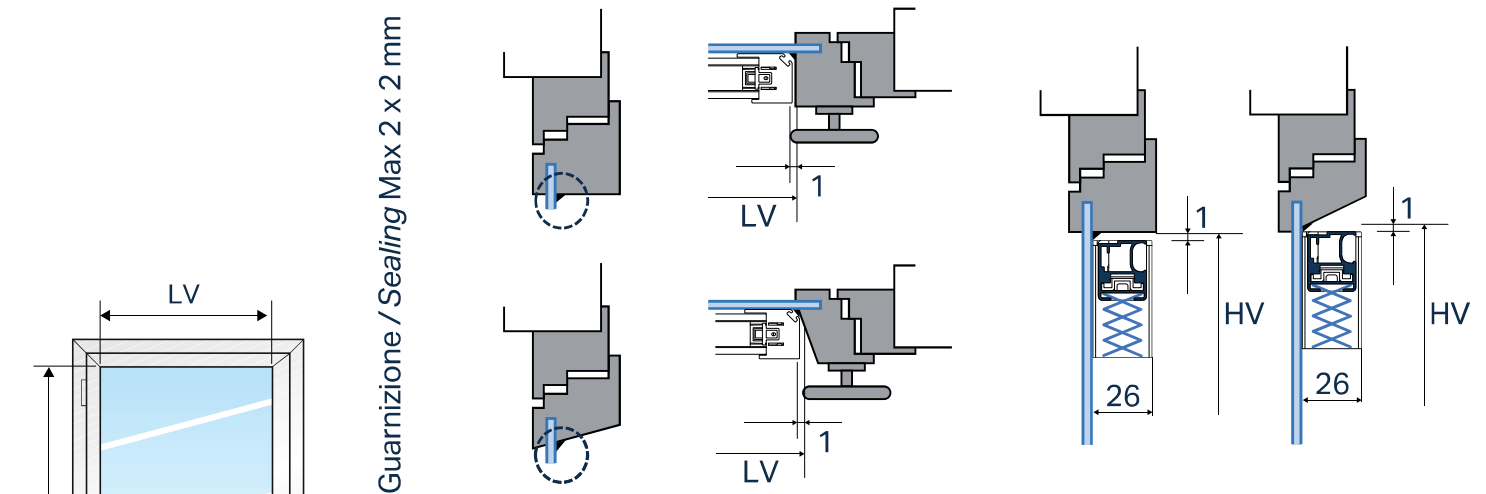

Guarnizione / Sealing > 2 x 2 mm

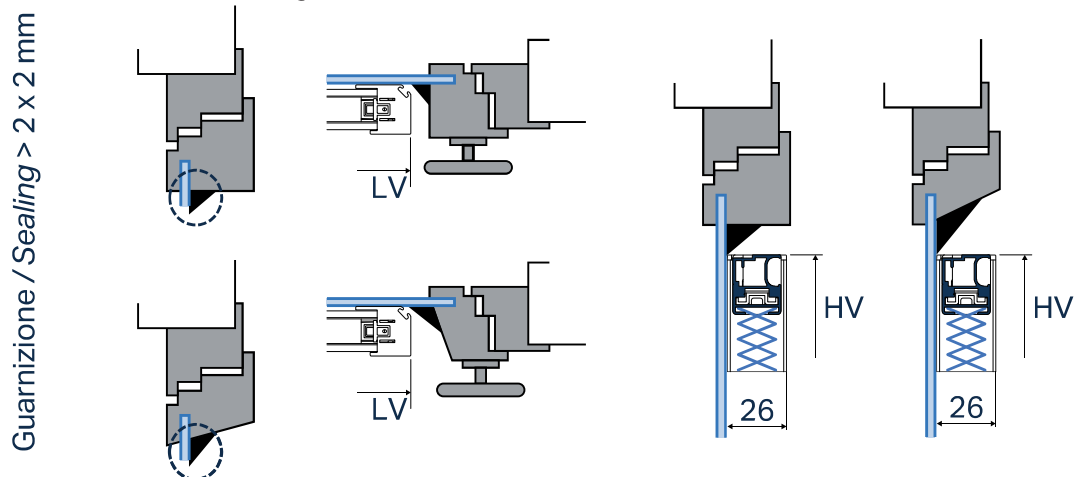



9.1.32

Plix 353

