

**VENETIAN BLINDS**

**MOTTURA**

# Venì

## GAMMA COLORI

La gamma Venì è progettata per adattarsi perfettamente a qualsiasi ambiente grazie ad una vasta scelta di colori eleganti e versatili. La qualità del prodotto è garantita dall'uso di una speciale verniciatura resistente agli agenti atmosferici e dallo spessore della lamella di 0,22 mm che assicura durata, robustezza e un'estetica impeccabile.

## COLOURS RANGE

*Venì range is designed to fit perfectly into any environment thanks to a wide choice of elegant and versatile colors.*

*The quality of the product is guaranteed by the use of a special weather-resistant paint and the thickness of the slat of 0.22 mm which ensures durability, strength and impeccable aesthetics.*

## MONOCOMANDO

Venì nelle versioni 16 e 25 mm sono disponibili anche con un pratico azionamento a monocomando a catenella che semplifica l'utilizzo e garantisce un risultato estetico moderno e pulito.

## MONOCONTROL

*Venì 16 and 25 mm versions are also available with a practical monocontrol chain drive which simplifies use and guarantees a modern and clean aesthetic result.*

## SAFETY CHILD

Venì, sia quelle con azionamento a corda che quelle con sistema mono comando a catena, sono dotate di un dispositivo di sicurezza anti-strangolamento per bambini Child Safety Device. Questo sistema è conforme alla norma europea EN 13120 che regola i requisiti di sicurezza per tende e veneziane, garantendo la massima protezione per i più piccoli.

## SAFETY CHILD

*Venì, both those with cord operation and those with a single chain control system, are equipped with anti-strangulation safety device for children Child Safety Device.*

*This system complies with the European standard EN 13120 which regulates the safety requirements for curtains and Venetian blinds, ensuring maximum protection for the little ones.*

## HOME AUTOMATION

Rendi smart la tua casa controllando la tua tenda con l'interfaccia M2Net di Mottura S.p.a. M2Net è la piattaforma Mottura sviluppata per la gestione ed il controllo dei propri sistemi motorizzati che permette un continuo dialogo bidirezionale tra i dispositivi di comando ed i sistemi motorizzati. M2Net Station è il collegamento di Mottura con il web. Un prodotto "user-friendly", facile da installare e registrare.

## HOME AUTOMATION

*Be smart controlling your curtain by M2Net interface. M2Net has been developed by Mottura to control its own motorized systems. It allows a continuous two-way dialogue between the transmitter and R.F. receiver integrated in the motorized systems. M2Net Station is the link between Mottura and the web. A user-friendly product, easy to install and record.*



# VENÌ 16 - 25 mm

TENDA VENEZIANA PER INTERNI CON LAMELLE  
ORIENTABILI IN ALLUMINIO 16 - 25 mm  
/ VENETIAN BLIND FOR INTERIORS WITH 16 - 25 mm  
ADJUSTABLE ALUMINIUM SLATS

Tenda confezionata con cassonetto, arresto laterale e  
asta di orientamento, supporti a soffitto.

NB: Per la versione a motore 24vdc la movimenta-  
zione di gruppo non garantisce uguale velocità di scor-  
rimento e l'orientamento sincronizzato delle lamelle.

Standard packing including: headbox, lateral box,  
adjustment rod and ceiling support.

NB: In the 24vdc motorized version the group opera-  
tion does not grant the same sliding speed and syn-  
chronised slats tilting.

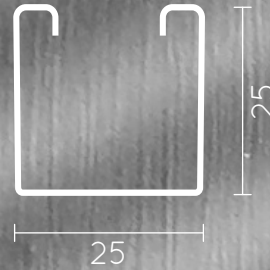

# VENÌ 50 mm

INDOOR

TENDA VENEZIANA PER INTERNI CON LAMELLE  
ORIENTABILI IN ALLUMINIO 50 mm  
/ VENETIAN BLIND FOR INTERIORS WITH 50 mm  
ADJUSTABLE ALUMINIUM SLATS

Tenda confezionata con cassonetto, comando a cor-  
da o motorizzato, supporti a soffitto o parete  
/ Awning packaged with box, cord or motorized con-  
trol, ceiling or wall supports

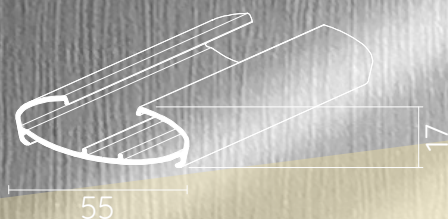
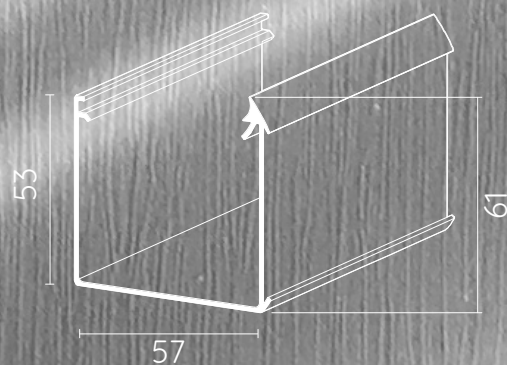

# VENÌ 50 mm

OUTDOOR

TENDA VENEZIANA PER ESTERNI CON LAMELLE  
ORIENTABILI IN ALLUMINIO 50 mm  
/ OUTDOOR VENETIAN BLIND FOR INTERIORS WITH  
50 mm ADJUSTABLE ALUMINIUM SLATS

Tenda confezionata con cassonetto, comando a  
corda, motorizzato o ad arganello, supporti a soffitto  
o parete

/ Awning packaged with cassette, cord, motorized or  
winch control, ceiling or wall supports

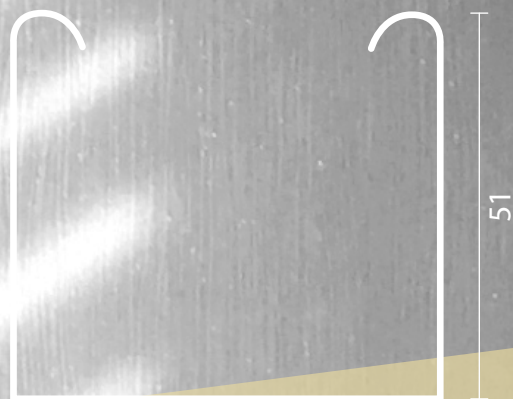

# INGOMBRO ED INSTALLAZIONI / OVERALL DIMENSIONS AND INSTALLATIONS

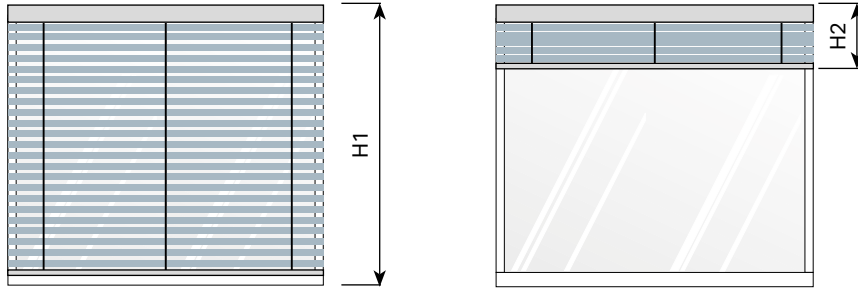

16-25 mm	
H1	H2
100 cm	8 cm
200 cm	12 cm
300 cm	16 cm

50 mm INDOOR		
H1	H2	
	nastro / tape	scaletta corda
50 cm	11	10
100 cm	13	12
150 cm	18	17
200 cm	20	19
250 cm	22	21
300 cm	24	23
350 cm	26	25

50 mm OUTDOOR		
H1	H2	
	nastro / tape	scaletta corda
50 cm	8	7
100 cm	10	9
150 cm	15	14
200 cm	17	16
250 cm	19	18
300 cm	21	20
350 cm	23	22

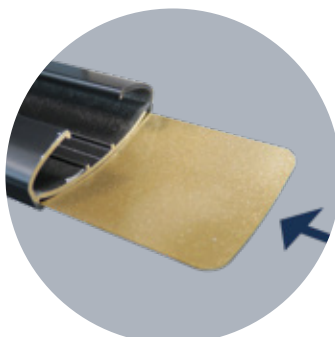
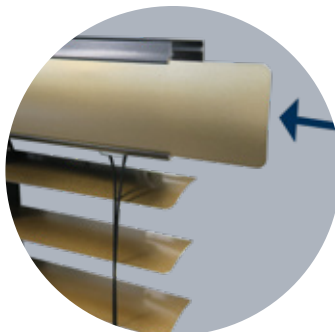
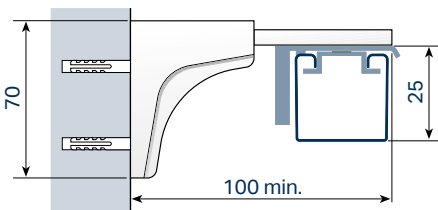
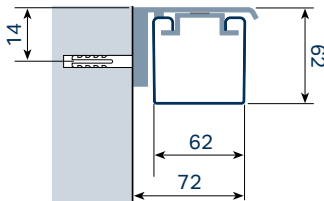
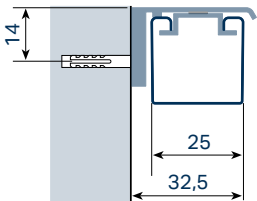
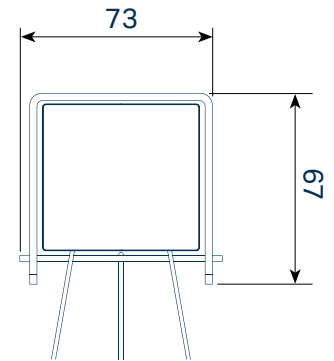
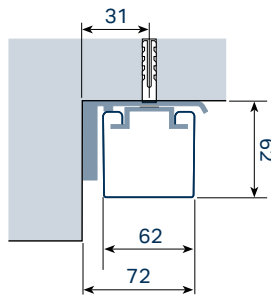
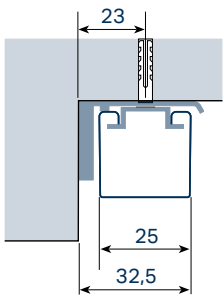

## 16 mm - DIMENSIONI / DIMENSIONS

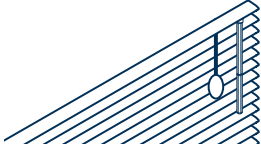
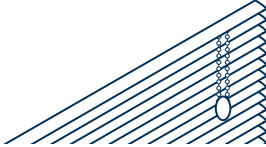
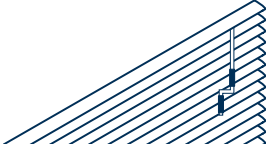
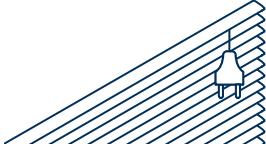
MAX AREA	6 m <sup>2</sup>	6 m <sup>2</sup>	6 m <sup>2</sup>	5 m <sup>2</sup>
L MAX	2800 mm	2800 mm	2800 mm	2800 mm
L MIN	260 mm	500 mm	500 mm	505 mm
H MAX	3000 mm	3000 mm	3000 mm	3000 mm
	DOPPIO COMANDO CORD/ROD CONTROL	MONOCOMANDO A CATENELLA CHAIN OPERATING	MONOCOMANDO AD ARGANELLO HANDLE	MONOCOMANDO MOTORE 24VDC 24VDC MOTOR
				



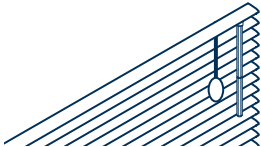
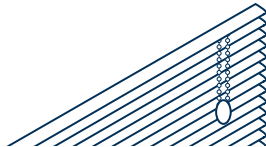
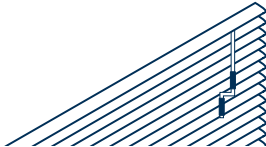
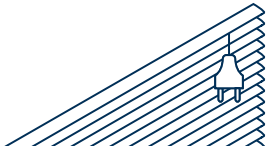

## 25 mm - DIMENSIONI / DIMENSIONS

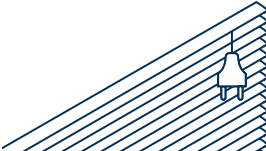
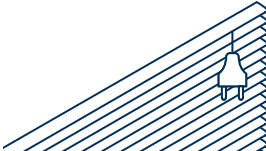
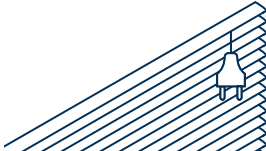
MAX AREA	6 m <sup>2</sup>	6 m <sup>2</sup>	6 m <sup>2</sup>	5 m <sup>2</sup>
L MAX	3000 mm	3000 mm	3000 mm	3000 mm
L MIN	260 mm	500 mm	500 mm	505 mm
H MAX	3000 mm	3000 mm	3000 mm	3000 mm
	DOPPIO COMANDO CORD/ROD CONTROL	MONOCOMANDO A CATENELLA CHAIN OPERATING	MONOCOMANDO AD ARGANELLO HANDLE	MONOCOMANDO MOTORE 24VDC 24VDC MOTOR
				

## 50 mm INDOOR - DIMENSIONI / DIMENSIONS

L MAX	300 cm	300 cm	300 cm	300 cm
L MIN	30 cm	55 cm	66 cm	76 cm
H MAX	350 cm	350 cm	350 cm	350 cm
	A CORDA CORD CONTROL	A MOTORE MOTORIZED	A MOTORE RADIO MOTORIZED BY RADIO MOTOR	A MOTORE M2NET MOTORIZED BY M2NET MOTOR
				

## 50 mm OUTDOOR - DIMENSIONI / DIMENSIONS

L MAX	300 cm	300 cm	300 cm	300 cm	300 cm
L MIN	30 cm	55 cm	66 cm	76 cm	60 cm
H MAX	350 cm	350 cm	350 cm	350 cm	350 cm
	A CORDA CORD CONTROL	A MOTORE MOTORIZED	A MOTORE RADIO MOTORIZED BY RADIO MOTOR	A MOTORE M2NET MOTORIZED BY M2NET MOTOR	AD ARGANELLO CRANK OPERATED
					

**Quando la luce del giorno penetra  
attraverso le lamelle inonda  
l'ambiente di una luce soffusa,  
creando una piacevole e calda  
atmosfera.**

