



DRAPPEGGI

DRAPERY TRACK SYSTEMS

MOTTURA

Plus

1

LA GAMMA

Una gamma completa di sistemi professionali per tende arriciate ad uso domestico e professionale che offre la soluzione più adatta per qualsiasi drappeggio.

THE RANGE

A full range of curtain track systems suitable for domestic and professional use which offers the best solutions for all curtain styles and qualities of fabrics.

2

LA SINERGIA

Un prodotto Mottura è il risultato dell'incontro tra la tecnologia Mottura e l'esperienza di migliaia di specialisti che da oltre quarant'anni la utilizzano ovunque nel mondo e contribuiscono ad una costante evoluzione del prodotto. Silenziosità e scorrevolezza come risultato di una tecnologia sofisticata per garantire una prestazione ed una longevità superiori.

THE SINERGY

A Mottura system is a result of the advanced technology at Mottura and the experience of thousands of experts who over 40 years have contributed to the constant evolution of our products.

3

LA QUALITÀ E I MATERIALI

Mottura pone una estrema attenzione all'utilizzo di materiali più adatti alle performance del prodotto. Oltre trenta materiali diversi sono stati selezionati ed utilizzati nei sistemi Mottura per offrire la performance migliore e una longevità estrema.

THE QUALITY & THE RAW MATERIAL

Mottura sets very high standards and spends a great deal of time to ensure we use the best materials to produce a high level of performance from our products. Over thirty different materials have been selected and are used constantly in the systems produced by Mottura, to offer the best performance and a long life. Sophisticated technology we can produce quiet and smooth running Curtain Systems and guarantee excellent performance and longevity.



Sistemi per drappeggi ad onda / Wave curtains systems

I sistemi per tende Mottura, sia con azionamento a corde che a strappo, sono adatti per tende ad arricciatura continua ad onda. L'arricciatura continua della tenda è realizzata per mezzo di una corda distanziatrice all'interno del canale di scorrimento degli scivoli.

Mottura systems, either cord drawn and hand drawn are suitable for continuous wave draping. Continuous curtain draping is achieved by means of a spacer cord inside the channel along which the sliders run.



Sistema / System		
STRALYS 477	•	•
IRYS	•	•
LUNA 577	•	
LIME 677	•	
ESSE 433	•	•
KUADRO 482	•	•
CASPER 101	•	
EGO 480	•	•

Sistema / System		
PROGETTO 420		•
SEPARÈ 459	•	•
SEPARÈ 458	•	
CLASS	•	•
ROUND 468	•	•
ARCO 489	•	

APERTURA LATERALE / LATERAL OPENING

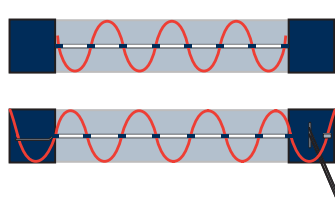

APERTURA CENTRALE / CENTRAL OPENING

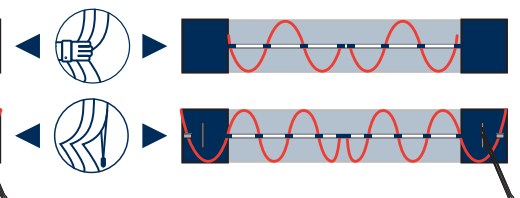

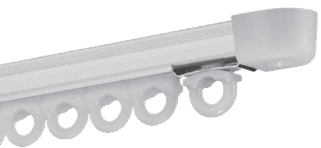

ZENITH 423

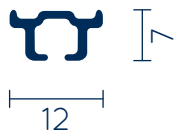

Ref. 4361	2 m		4 m		Ref. 4361	2 m		4 m		
		3 kg	5 kg					1 kg	2 kg	
		2 kg	4 kg				1 kg	2 kg		



NADIR 426



Ref. 4361	2 m		4 m		Ref. 4361	2 m		4 m		
		3 kg	5 kg					1 kg	2 kg	
		2 kg	4 kg				1 kg	2 kg		



ORIZZONTE 466

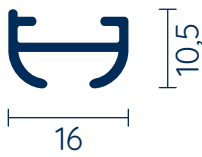

Ref. 4263	2 m		4 m		Ref. 4263	2 m		4 m		
		8 kg	6 kg					3 kg	3 kg	
		7 kg	5 kg				3 kg	3 kg		



ORIZZONTE 806

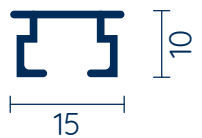

Ref. 4263	2 m		4 m		Ref. 4263	2 m		4 m		
		8 kg	7 kg					3 kg	3 kg	
		7 kg	6 kg				3 kg	3 kg		



MULTIPLO 412

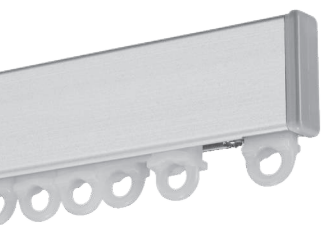
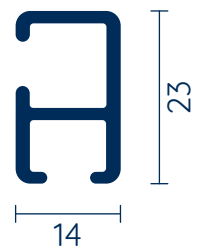

SPIN 417



Ref. 4361	2 m		4 m		6 m		Ref. 4361	2 m		4 m		6 m	
		3 kg	5 kg	2 kg						1 kg	2 kg	1 kg	
		2 kg	4 kg	2 kg					1 kg	2 kg	1 kg		



ARCO 489

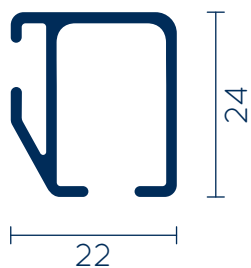

Ref. 4263	2 m		4 m		6 m		Ref. 4263	2 m		4 m		6 m	
		14 kg	20 kg	18 kg						6 kg	8 kg	8 kg	
		12 kg	17 kg	15 kg					6 kg	8 kg	8 kg		



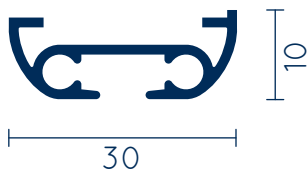

Ref. 4263	2 m	4 m	6 m
	5 kg	7 kg	4 kg

BEST 421

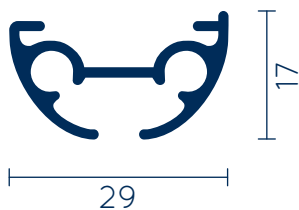

Ref. 4263	2 m	4 m	6 m
	6 kg	8 kg	5 kg
	3 kg	3 kg	2 kg

PROGETTO 420

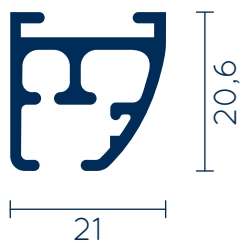

Ref. 4263	2 m	4 m	6 m	Ref. 4263	2 m	4 m	6 m
	7 kg	10 kg	6 kg		3 kg	4 kg	3 kg
	6 kg	8 kg	5 kg		3 kg	4 kg	3 kg

EGO 480

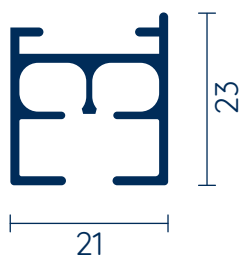

Ref. 4263	2 m	4 m	6 m	Ref. 4263	2 m	4 m	6 m
	7 kg	10 kg	6 kg		3 kg	4 kg	3 kg
	6 kg	8 kg	5 kg		3 kg	4 kg	3 kg

KUADRO 482

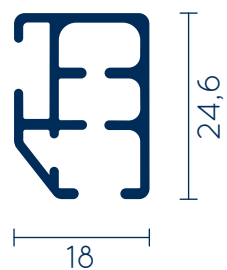

Ref. 4263	2 m	4 m	6 m	Ref. 4263	2 m	4 m	6 m
	10 kg	12 kg	8 kg		4 kg	5 kg	3 kg
	8 kg	10 kg	7 kg		4 kg	5 kg	3 kg

ARCO 470

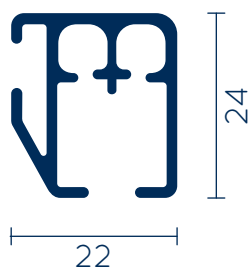

Ref. 4263	2 m	4 m	6 m	Ref. 4263	2 m	4 m	6 m
	7 kg	10 kg	8 kg		3 kg	4 kg	3 kg
	6 kg	8 kg	7 kg		3 kg	4 kg	3 kg

ARCO 490





SLALOM 430

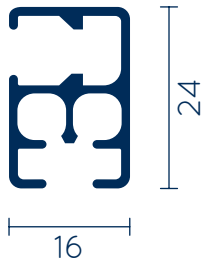

Ref. 4263	2 m	4 m	6 m	Ref. 4263	2 m	4 m	6 m
	7,5 kg	9 kg	5 kg		3 kg	4 kg	2 kg
	6 kg	7 kg	4 kg		3 kg	4 kg	2 kg



ESSE 433



Ref. 4263	2 m	4,5 m	6 m	Ref. 4263	2 m	4,5 m	6 m
	6 kg	8 kg	5 kg		3 kg	4 kg	2 kg
	5 kg	6 kg	4 kg		3 kg	4 kg	2 kg



ROUND 460

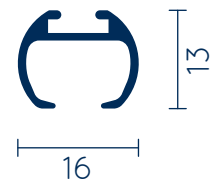

Ref. 4263	2 m	4 m	6 m	Ref. 4263	2 m	4 m	6 m
	6 kg	8 kg	5 kg		3 kg	3 kg	2 kg
	5 kg	7 kg	4 kg		3 kg	3 kg	2 kg



ROUND 462

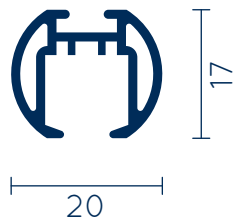

Ref. 4263	2 m	4 m	6 m
	8 kg	10 kg	7 kg
	7 kg	8 kg	6 kg
	3 kg	4 kg	3 kg
	3 kg	4 kg	3 kg



ROUND 463

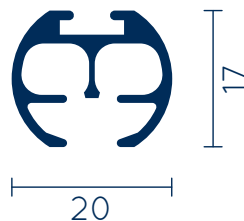

Ref. 4263	2 m	4 m	6 m
	4 kg	6 kg	4 kg



ROUND 468

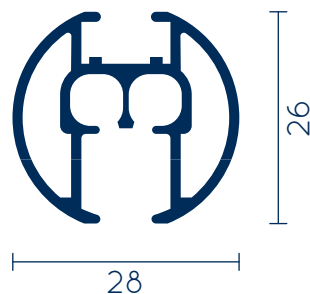

Ref. 4263	2 m	4 m	6 m
	6 kg	8 kg	4 kg
	5 kg	7 kg	3 kg
	3 kg	3 kg	2 kg
	3 kg	3 kg	2 kg



SEPARÈ 458

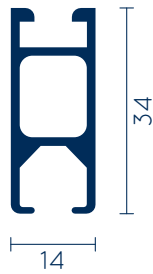

Ref. 4263	2 m	4 m	6 m	Ref. 4263	2 m	4 m	6 m
	7 kg	11 kg	8 kg		3 kg	5 kg	3 kg
	6 kg	9 kg	7 kg		3 kg	5 kg	3 kg



SEPARÈ 459

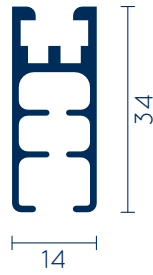

Ref. 4263	2 m	4 m	6 m	Ref. 4263	2 m	4 m	6 m
	8 kg	11 kg	10 kg		3 kg	5 kg	4 kg
	7 kg	9 kg	8 kg		3 kg	5 kg	4 kg



CLASS 455

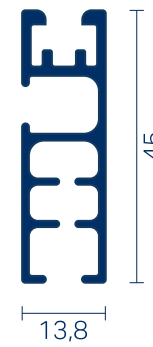

Ref. 4263	2 m	4 m	6 m
	6 kg	8 kg	5 kg



SURF 311

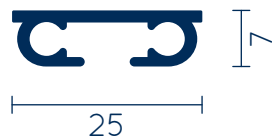

Ref. 4263	2 m	4 m	6 m
	6 kg	9 kg	6 kg
	3 kg	4 kg	3 kg



SURF 322



Ref. 4263	2 m	4 m	6 m
	6 kg	9 kg	6 kg
	3 kg	4 kg	3 kg



SURF 324



Ref. 4263	2 m	4 m	6 m
	6 kg	10 kg	6 kg



STRALYS 477



Ref. 4263	2 m	4 m	6 m
	6 kg	9 kg	6 kg

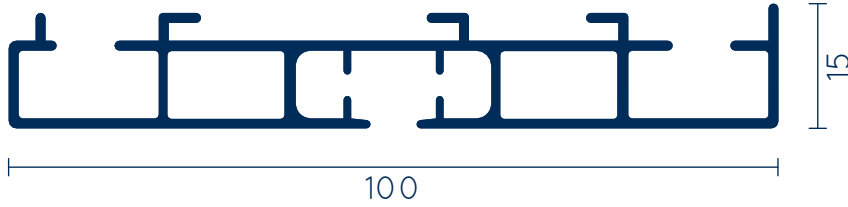

IRYS 177

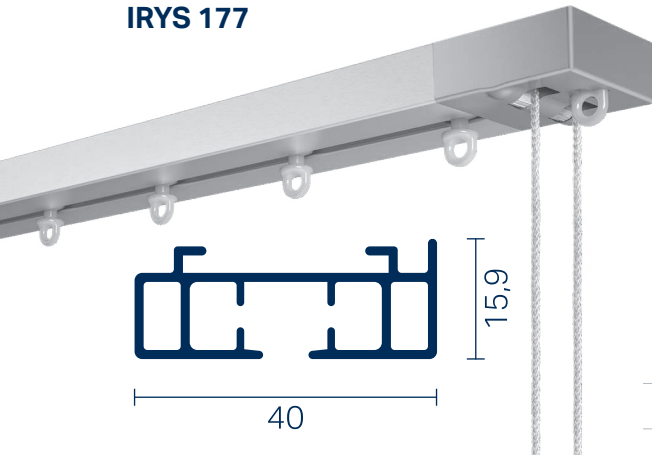

Ref. 4263	2 m	4 m	6 m
	6 kg	8 kg	5 kg

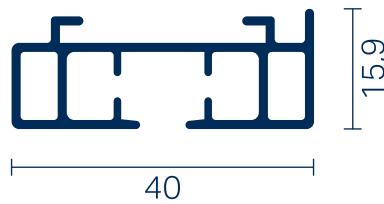

LIME 677



Ref. 4263	2 m	4 m	6 m
	6 kg	9 kg	6 kg

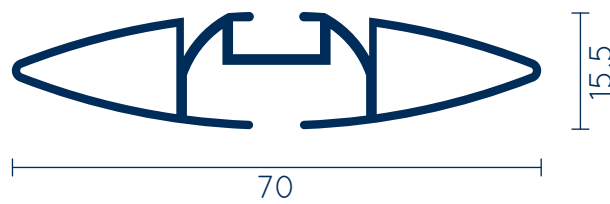

LUNA 577



Ref. 4263	2 m	4 m	6 m
	6 kg	9 kg	6 kg

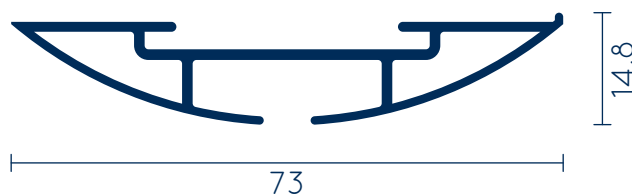

CASPER 101 e 201

Sistemi ad incasso

/ Concealed curtains systems



Sistemi ad incasso per tende arciate indicato per uso domestico ed alberghiero, destinati ad applicazioni in controsoffitti in cartongesso per la sospensione di sottotende (Casper 101) o per la sospensione di tende o sovratende che necessitano di un ampio sormonto (Casper 201).

Concealed systems for draperies for domestic and hotels System designed for applications in plasterboard false ceilings for single curtains (Casper 101) or curtains/overcurtains that require a large overlap (Casper 201).

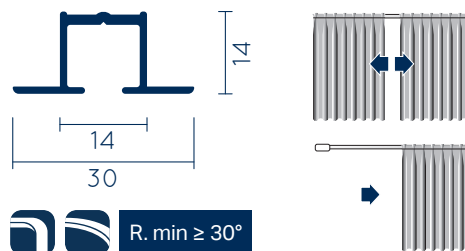
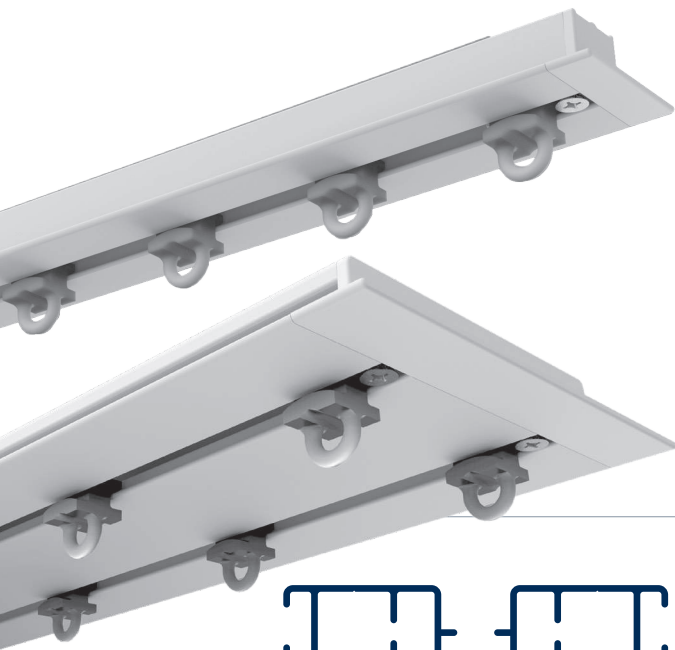

CASPER 101			
Ref. 4263	Kg	2 m	4 m
		4 kg	5 kg
		3 kg	4 kg
		3 kg	4 kg

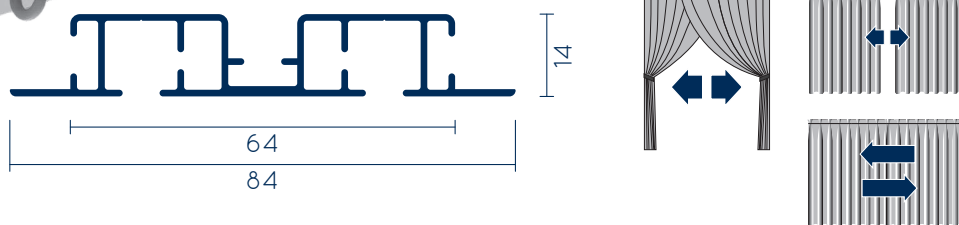

CASPER 201			
Ref. 4263	Kg	2 m	4 m
		4 kg	6 kg

SIPARIO 202

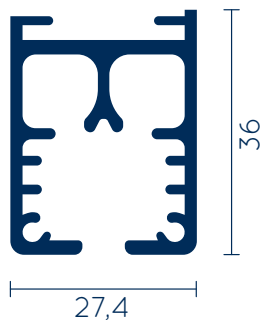
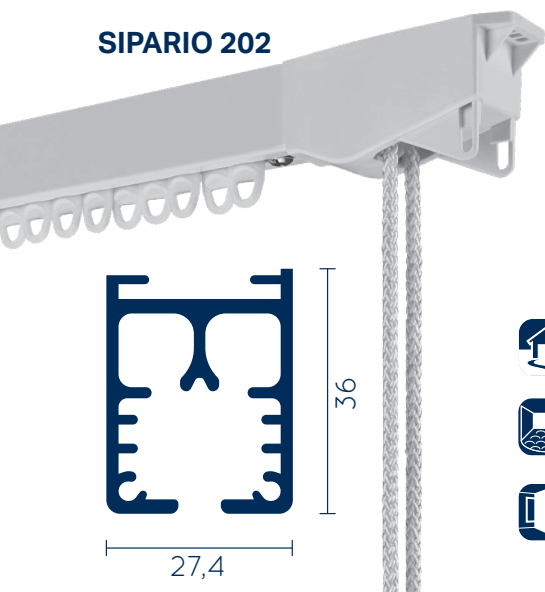

Ref. 5020	2 m	4 m	6 m	8 m	10 m	12 m	14 m	16 m
	13 kg	38 kg	50 kg	50 kg	50 kg	43 kg	33 kg	23 kg
	10 kg	31 kg	41 kg	41 kg	41 kg	35 kg	27 kg	19 kg
	4 kg	15 kg	18 kg	18 kg	18 kg	33 kg	25 kg	17 kg
	4 kg	15 kg	18 kg	18 kg	18 kg	33 kg	25 kg	17 kg

Ref. 5028	2 m	4 m	6 m	8 m	10 m	12 m	14 m	16 m
	15 kg	40 kg	55 kg	55 kg	55 kg	45 kg	35 kg	25 kg
	12 kg	33 kg	46 kg	46 kg	46 kg	37 kg	29 kg	21 kg
	6 kg	17 kg	23 kg	23 kg	23 kg	19 kg	15 kg	11 kg
	6 kg	17 kg	23 kg	23 kg	23 kg	19 kg	15 kg	11 kg

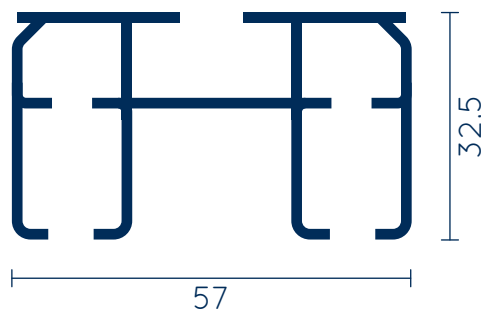

TEATRO 404

Ref. 5020	2 m	4 m	6 m	8 m	10 m	12 m	14 m	16 m	18 m	20 m
	8 kg	18 kg	25 kg	35 kg	40 kg	50 kg	50 kg	43 kg	32 kg	18 kg

Ref. 5028	2 m	4 m	6 m	8 m	10 m	12 m	14 m	16 m	18 m	20 m
	10 kg	20 kg	30 kg	40 kg	45 kg	55 kg	55 kg	45 kg	35 kg	20 kg



Sistemi per tende multiple / Multiple curtains systems

MODULO 105

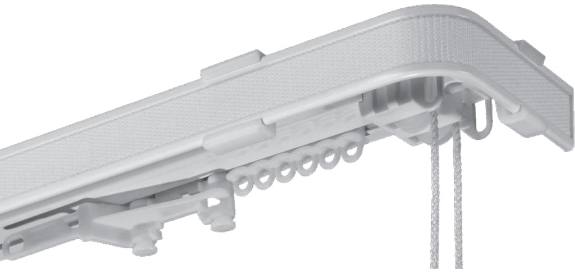

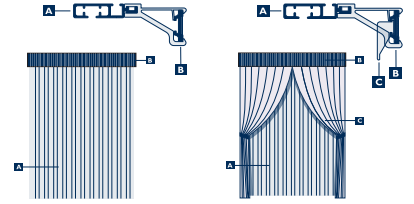

Ref. 4263	 Kg	2 m	4 m	6 m
		6 kg	10 kg	6 kg

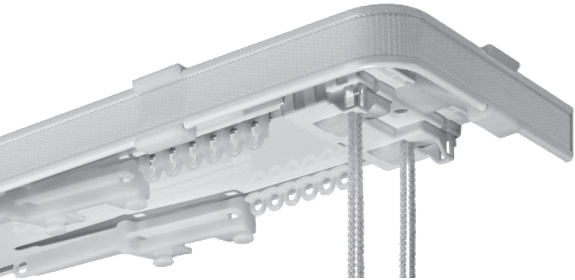

MODULO 205



Ref. 4263	 Kg	2 m	4 m	6 m
		6 kg	10 kg	6 kg

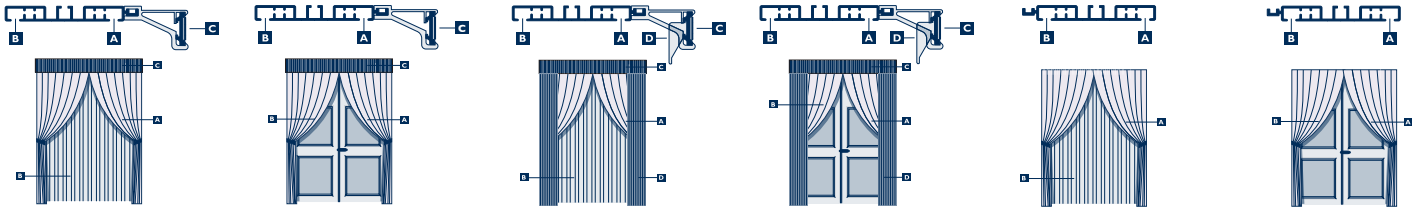

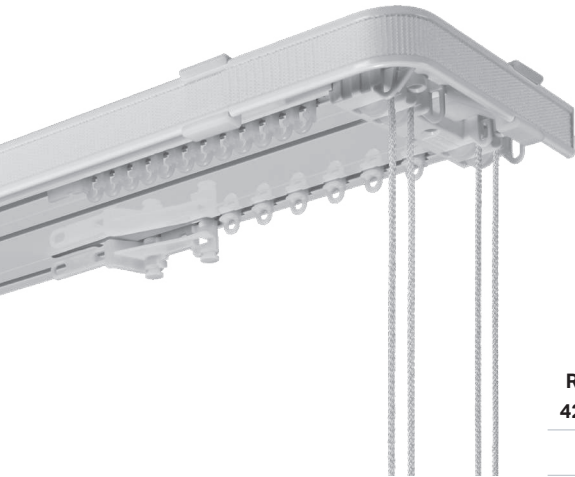

MODULO 305 - 306

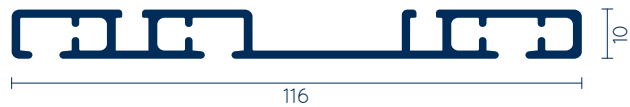

305



306

Ref. 4263	 Kg	2 m	4 m	6 m
		6 kg	9 kg	6 kg

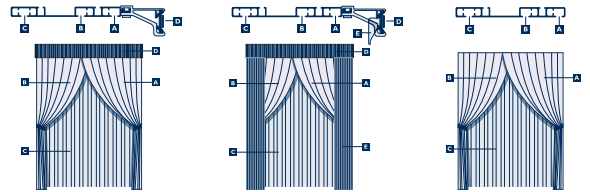

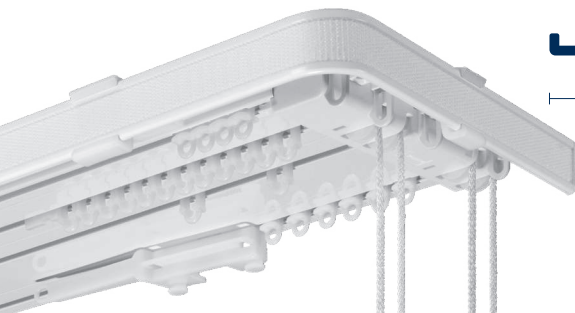

MODULO 405 - 406



405



406

Ref. 4263	 Kg	2 m	4 m	6 m
		7 kg	10 kg	8 kg

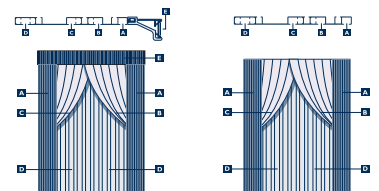

SISTEMI
SYSTEMS

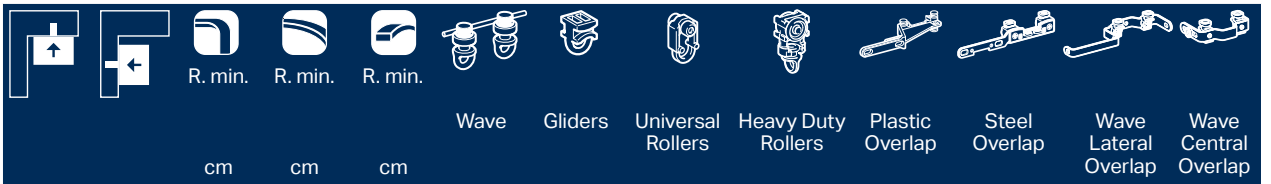

			cm	cm	cm	Wave	Gliders	Universal Rollers	Heavy Duty Rollers	Plastic Overlap	Steel Overlap	Wave Lateral Overlap	Wave Central Overlap
SLALOM 430	•	•	12	50			•			•	•		
ARCO 470	•	•	12	50			•	•		•	•		
ARCO 489	•	•	12	50		•	•	•	•	•	•		•
ARCO 490	•	•	12	50			•	•	•	•	•	•	•
ESSE 433	•	•	12	50		•	•	•		•	•	•	•
KUADRO 482	•	•	12	50		•	•	•		•	•	•	•
EGO 480	•	•	12	50		•	•	•		•	•	•	•
PROGETTO 420	•			150		•	•	•		•	•	•	•
BEST421	•						•			•	•		
ROUND 460 - 462	•	•	12/30	50		•	•	•			•		•
ROUND 463	•	•	40	50			•			•			
ROUND 468	•	•	30	50		•	•	•		•		•	•
SEPARÈ 458 - 459	•	•	12	50		•	•	•		•	•	•	•
CLASS 455													
SIPARIO 202	•	•	30	50					•		•		
TEATRO 404	•	•							•				
LUNA 577 - LIME 677	•					•	•			•	•		•
STRALYS 477	•	•				•	•			•	•		•
IRYS 177													
ZENITH 423	•		6/12	50			•						
NADIR 426	•	•	10	50			•						
ORIZZONTE 466 - 806	•	•	12	50			•				•		
SPIN 417	•	•	10	50	50		•						
MULTIPLO 412	•	•	12	50			•	•			•		
SURF 311 - 322	•				100		•			•	•		
SURF 324	•						•	•		•	•		
MODULO	•	•					•	•		•	•		
CASPER 101			30	100		•	•	•			•		•
CASPER 201						•	•	•			•		•

COLORI DISPONIBILI
SUITABLE COLOURS



	Argento Silver	Alluminio satinato Satined aluminium	Alluminio cromato Chromed aluminium	Bianco lucido Glossy white	Bianco opaco Matt white	Vaniglia Vanilla	Tortora Dove grey	Bronzo Bronze	Marrone Brown	Antracite Anthracite	Nero opaco Matt black	Oro Gold	
SLALOM 430	•			•				•			•	•	
ARCO 470	•			•							•	•	
ARCO 489	•			•							•	•	
ARCO 490	•			•				•			•	•	•
ESSE 433	•	•		•	•	•	•		•	•	•	•	
KUADRO 482	•	•		•	•	•	•		•	•	•	•	
EGO 480		•		•	•	•					•	•	
PROGETTO 420	•			•							•	•	
BEST421	•			•				•			•	•	
ROUND 460		•	•								•	•	
ROUND 462		•	•	•	•	•	•		•	•	•	•	
ROUND 463		•	•	•	•	•	•		•	•	•	•	
ROUND 468		•	•	•	•	•	•				•	•	
SEPARÈ 458		•		•	•	•			•	•	•	•	
SEPARÈ 459		•	•	•	•	•		•		•	•	•	
CLASS 455		•	•		•	•	•		•	•	•	•	
SIPARIO 202				•							•	•	
TEATRO 404				•							•	•	
LUNA 577		•	•		•	•				•	•	•	
LIME 677		•	•	•	•	•			•	•	•	•	
STRALYS 477		•	•	•		•	•				•	•	
IRYS 177		•	•		•	•	•		•	•	•	•	
ZENITH 423	•			•									
NADIR 426	•			•									
ORIZZONTE 466 - 806*	•			•				•*					
SPIN 417	•			•				•			•	•	
MULTIPLO 412	•			•									
SURF 311* - 322	•			•				•*			•*	•*	
SURF 324				•									
MODULO				•									
CASPER 101 - 201				•									

OTHER
COLORS
ON
REICH
DEMAND

