

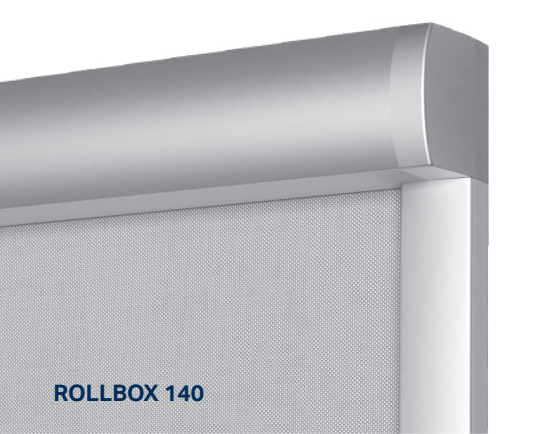

FRAMES

WINDOW TECHNOLOGY

MOTTURA



UNA GAMMA DEDICATA

Rollbox 40 e 60 sono tende a rullo filtranti ed oscuranti specifiche per installazione diretta senza foratura su serramenti. Sono tende tecniche indicate per ogni genere di finestra: anta singola, porta finestra, anta ribalta, lucernari inclinati, vetrate fisse.

A CUSTOM MADE PRODUCT RANGE

Rollbox 40 and 60 are filtering or blackout roller blinds designed for specific application on every type of windows and doors without any hole to be installed. They are suitable for: balcony door, French window, turn&tilt window, tilted skylights, and fixed windows.



ROLLBOX 140 – 160

Sono tende a rullo con cassonetto ad uso filtrante ed oscurante con azionamento a molla Multistop che permette l'arresto della tenda in qualsiasi posizione. È la versione specifica per finestre ad anta singola, anta ribalta e vetrate fisse ad altezza davanzale. **Rollbox 140** L max 120 H max 240 **Rollbox 160** L max 140 H max 260.

*Roller blinds with cassette filtering and blackout use with Multistop spring drive that allows the blind to stop in any position. It is the specific version for single-wing windows, tilt-and-turn windows and fixed windows at the height of the windowsill. **Rollbox 140** L max 120 H max 240 **Rollbox 160** L max 140 H max 260.*

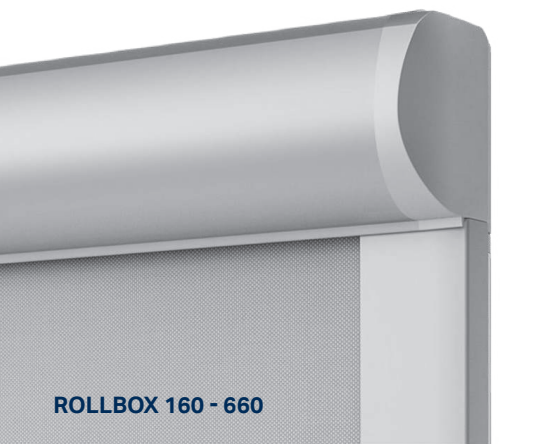

ROLLBOX 240 – 260

Sono tende a rullo con cassonetto ad uso filtrante ed oscurante con azionamento a catenella specifiche per finestre ad anta singola, anta ribalta, doppia anta e porta finestra. **Rollbox 240** L max 120 H max 240 **Rollbox 260** L max 160 H max 260.

*Filtering and blackout roller blinds with cassette direct chain operating specific for single-wing windows, tilt-and-turn windows, double doors and French doors. **Rollbox 240** L max 120 H max 240 **Rollbox 260** L max 160 H max 260.*



ROLLBOX 660

È la versione multistop specifica per lucernari fissi o basculanti orizzontali o verticali ad uso filtrante ed oscurante. Le guide laterali in alluminio con zip evitano la fuoriuscita del tessuto in qualsiasi condizione. L max 120 H max 160.

It is the specific multistop version for fixed or tilting horizontal or vertical skylights for filtering and blackout use. The side guides in aluminum with zip guarantee that the fabric can escape in any condition. L max 120 H max 160.

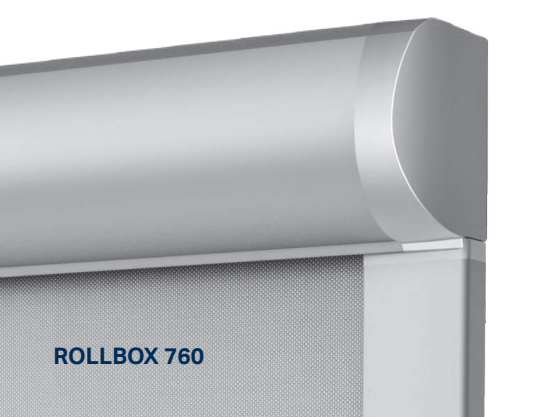

ROLLBOX 760

È la versione a motore a batteria ideale per installazione diretta su serramento in quanto non richiede alcun cablaggio. Le batterie Li-Ion integrate garantiscono una autonomia di 1 anno in stand by oppure 400 azionamenti. Il telecomando R.F. è incluso. L max 160 H max 260.

It is the most suitable motor system for direct installation on a window as it does not require any wiring. The integrated Li-Ion batteries rechargeable guarantees an autonomy of 1 year in stand by or 400 operations. R.F. transmitter is included. L max 160 H max 260.

Plus

1

DESIGN E TECNOLOGIA

Rollbox 40 e 60 non sono solo una protezione solare ma un complemento di design semplice e lineare che si integra perfettamente nella finestra. L'involucro in alluminio è anche garanzia di longevità del prodotto.

DESIGN AND TECHNOLOGY

Rollbox 40 and 60 is not only a sunscreen but a complement to simple, straightforward design that integrates perfectly on the window. The aluminum box is also a guarantee a long life product.

2

INSTALLAZIONE

Rollbox 40 e 60 vengono installati direttamente sul vetro del serramento, per mezzo di Velcro® o di uno specifico biadesivo. Questa caratteristica gli permette di adattarsi a differenti tipologie di serramento in alluminio, legno o PVC ed inoltre permette di installare la tenda senza effettuare alcun foro.

INSTALLATION

Rollbox 40 and 60 are installed directly on the glass of the window frame, using Velcro® or a specific adhesive. This feature allows the system to adapt to different window or door types: aluminum, wood or PVC, and also allows you to install the blinds without making any hole.

3

MINIMO INGOMBRO

Rollbox 40 e 60 sono prodotti progettati per integrarsi nel serramento creando il minimo ingombro e ciò permette ad essi un ampio spettro di utilizzo.

La serie 40 e 60 permettono un'installazione diretta su serramento anche in caso di una porta finestra o di una finestra anta ribalta.

MINIMUM SIZE

Rollbox 40 and 60 are products designed to integrate into the frame, creating a minimum overall and this is what allows them to a wide spectrum of use.

Series 40 and 60 allow a direct installation on the frame in the event of a balcony door or a tilt & turn window.

4

SEMPLICITÀ

Rollbox 140 è dotato di un dispositivo che permette di modificare la carica della molla in modo semplice e sicuro.

L'installazione mediante velcro permette la rimozione del rullo dal serramento per una eventuale manutenzione.

SEMPPLICITY

Rollbox 140 is equipped with a device which allows to change the position of the spring in a simple and fast way.

The installation with Velcro allows the removal of the roller from the frame for a possible maintenance.



5

BLACKOUT

La serie 40, che è dotata di guide laterali in alluminio ed un profilo inferiore specifico garantisce una buona qualità di oscuramento.

Rollbox serie 60 è una tenda blackout.

Le guide laterali in alluminio con zip ed una speciale guarnizione posteriore non permettono alla luce di filtrare lateralmente mentre il profilo inferiore ferma la luce dal basso garantendo il buio completo nonostante il ridotto ingombro delle guide stesse.

BLACKOUT

Rollbox serie 40, which is equipped with aluminum side guides and a specific aluminium lower profile on demand, guarantees good darkening quality.

Rollbox 60 series is a blackout blind.

The aluminum side guides with zip and a special rear gasket do not allow the light to filter sideways while the lower profile stops the light from below, guaranteeing complete darkness despite the reduced overall of the guides themselves.



6

I TESSUTI TECNICI

Rollbox serie 40 e 60 sono disponibili con molte diverse tipologie di tessuti che rispondono alle più diverse esigenze della progettazione:

- filtranti
- oscuranti
- screen con fattore di apertura da 0% a 10%
- screen pvc free
- screen da riciclo PET
- filtranti ed oscuranti fonoassorbenti
- filtranti ed oscuranti antibatterici
- ignifughi Trevira CS®

TECHNICAL FABRICS

Rollbox 40 and 60 series are available with many different types of fabrics that meet the most diverse design needs:

- filtering
- blackout
- screen with opening factor from 0% to 10%
- screen pvc free
- PET recycling screen
- sound-absorbing filters and blackouts
- antibacterial filters and blackouts
- fireproof Trevira CS®

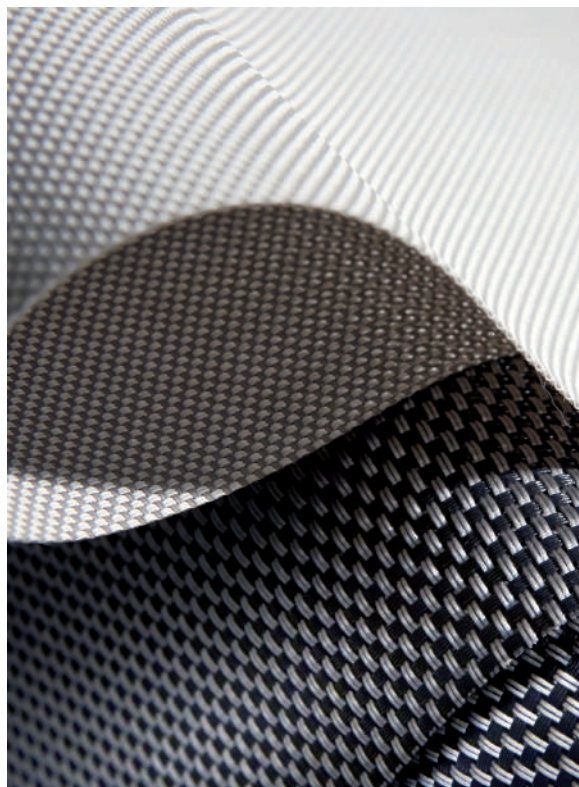

Applicazioni / Appliances



Installazioni / Installations

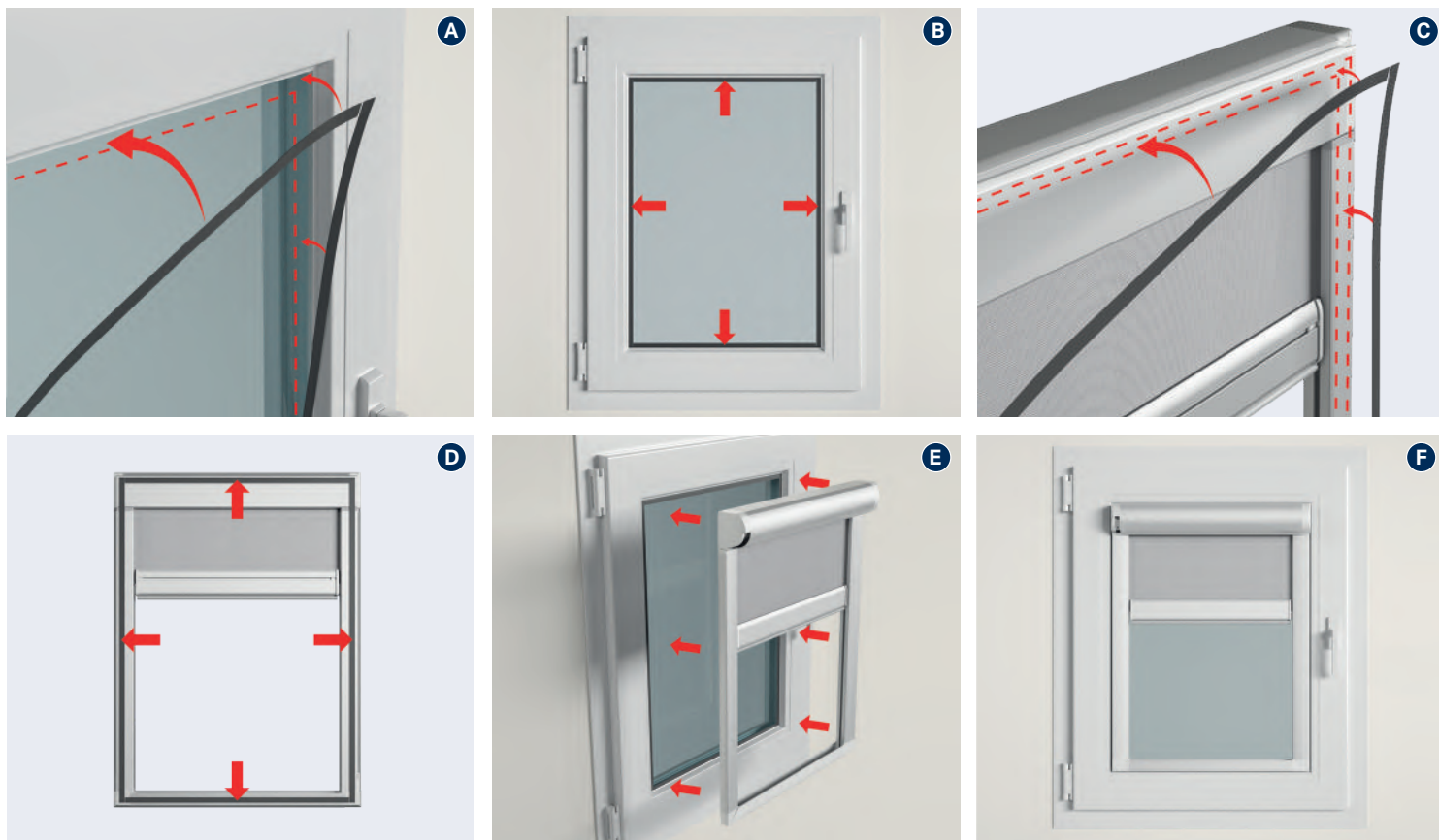

Installazioni / Installations

ROLLBOX 140 - 240

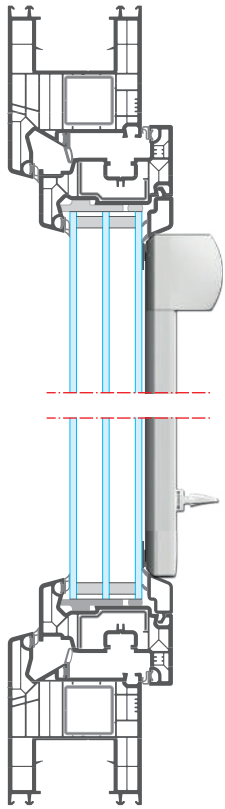

PVC

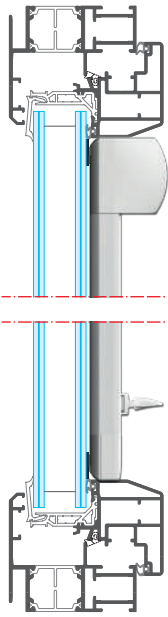

ALLUMINIO
Aluminium

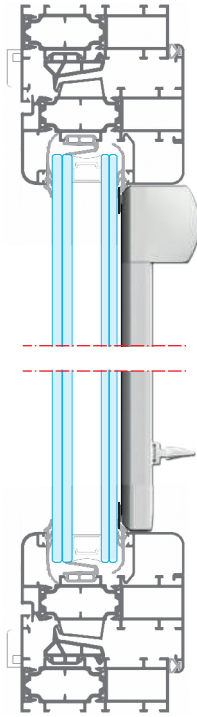

ALLUMINIO
Aluminium

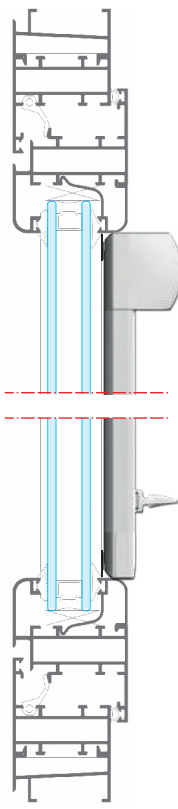

ALLUMINIO
Aluminium

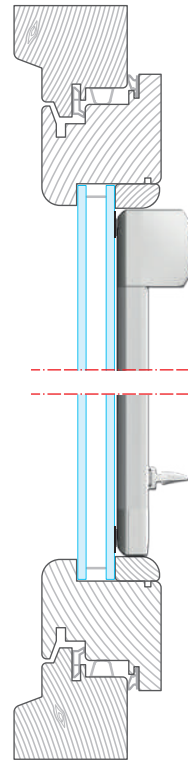

LEGNO
Wood

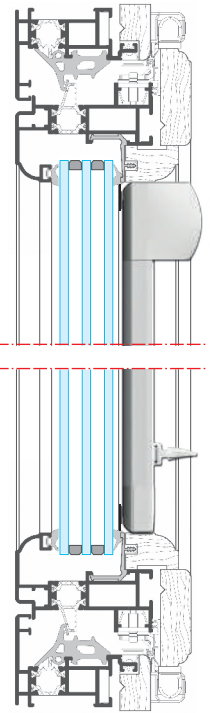

LEGNO / ALLUMINIO
Wood / Aluminium

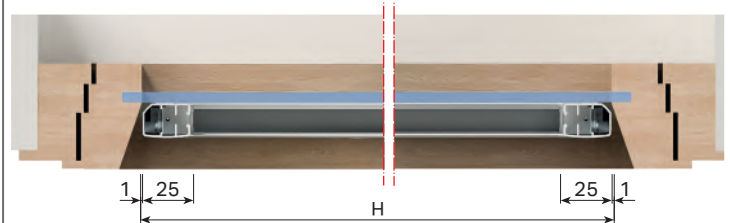
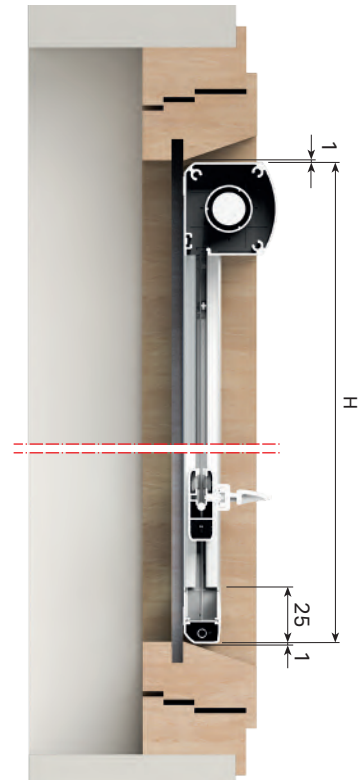
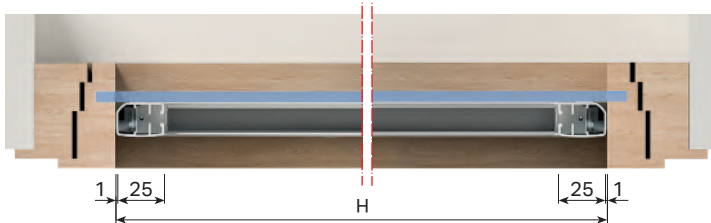
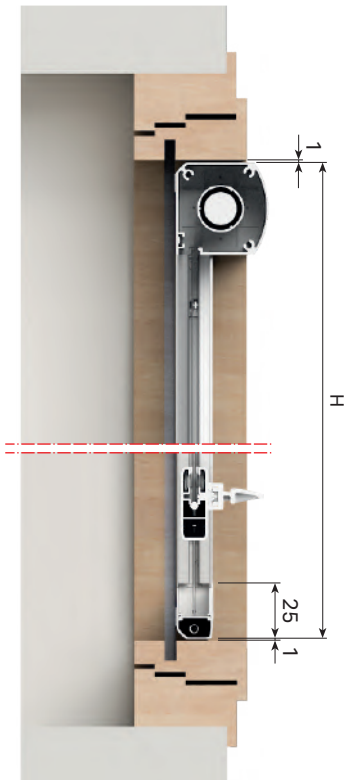
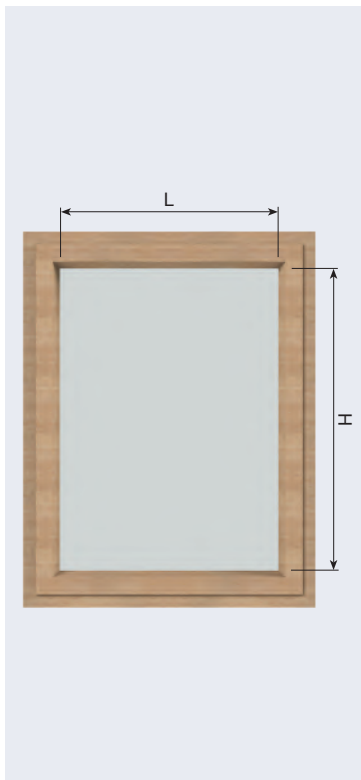

Installazioni / Installations

ROLLBOX 160 - 260 - 660 - 760

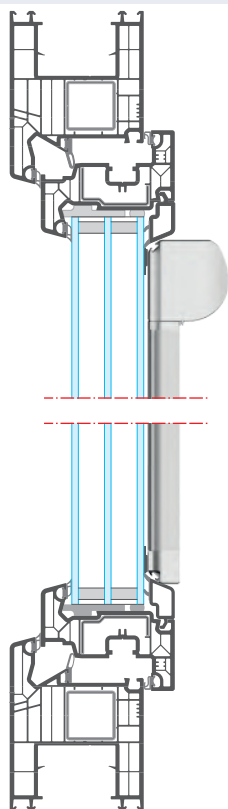

PVC

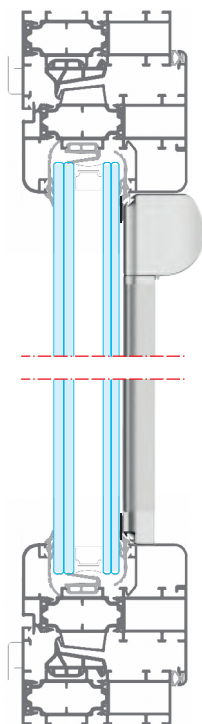

ALLUMINIO
Aluminium

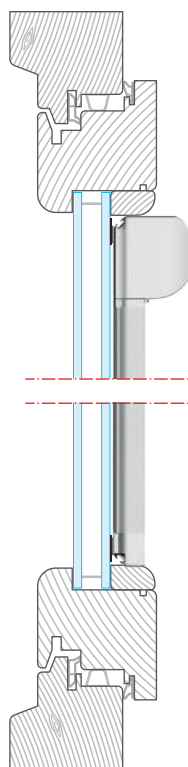

LEGNO
Wood

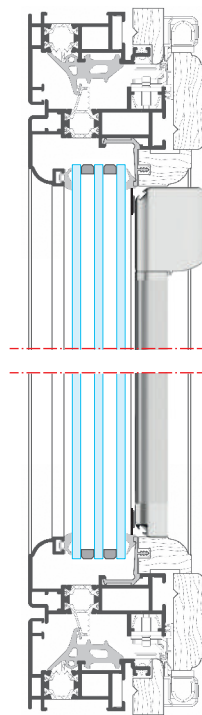

LEGNO / ALLUMINIO
Wood / Aluminium

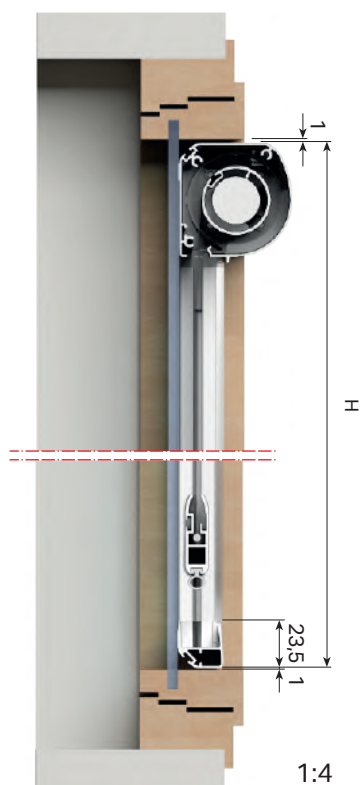
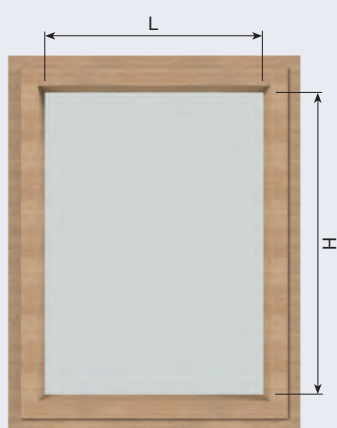

1:4

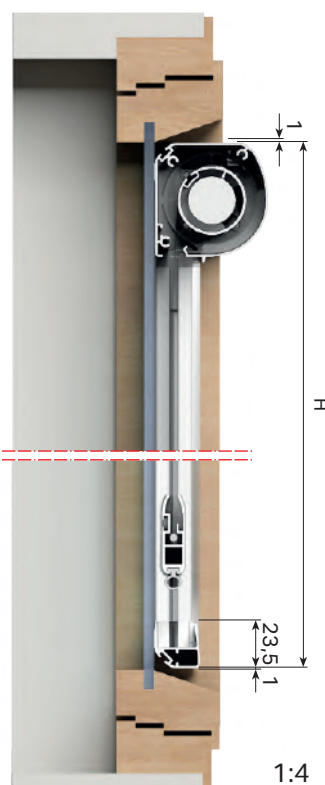

1:4

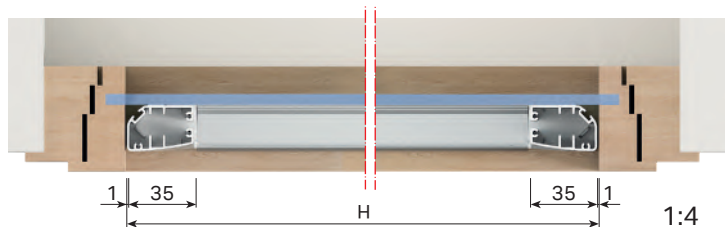

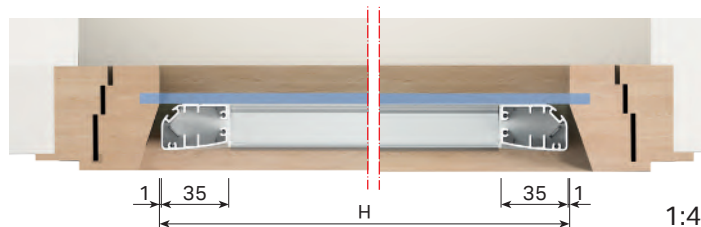

1:4

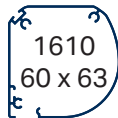

1:4

Azionamenti / Operations

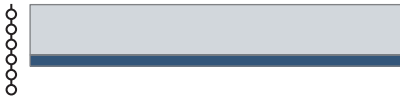
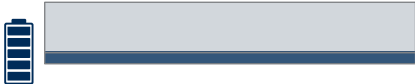
		
<p>AZIONAMENTO MANUALE MULTISTOP <i>MULTISTOP HAND DRAWN OPERATING</i></p> 	140	160 - 660
<p>AZIONAMENTO A CATENA <i>CHAIN OPERATING</i></p> 	240	260
<p>MOTORIZZATA A BATTERIA RICARICABILE <i>BUILT-IN BATTERY MOTORIZED</i></p> 	-	760

Multistop

I sistemi Rollbox 140, 160 e 660 sono dotati di multiarresto, una soluzione che permette l'arresto della tenda in qualsiasi posizione.

Rollbox 140, 160 and 660 are systems equipped with multistop, a device that allows the stop of the blind in any position.

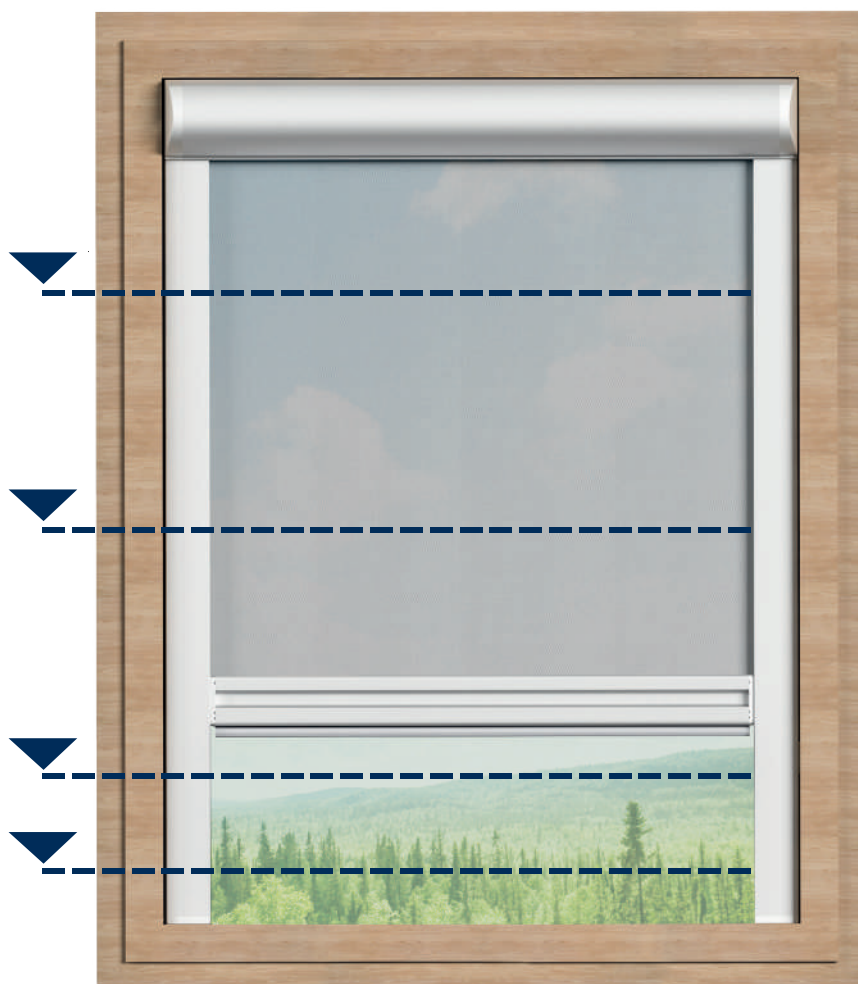

La gamma / The range

SISTEMA SYSTEM	AZIONAMENTO OPERATION		TESSUTI FABRICS			INSTALLAZIONE INSTALLATION		
			FILTRANTI FILTERING	ATTENUANTI DIM-OUT	OSCURANTI BLACK-OUT	VERTICALE VERTICAL	VASISTAS VASISTAS	LUCERNARI SKYLIGHTS
ROLLBOX 140	Azionamento manuale multistop <i>Hand drawn multistop operating</i>	45x45 mm	•	•	•	•	•	
ROLLBOX 240	Catena <i>Chain Operating</i>	45x45 mm	•	•	•	•	•	
ROLLBOX 160	Molla Decelerata <i>Decelerated Spring</i>	60x63 mm	•	•	•	•	•	
ROLLBOX 260	Catena <i>Chain Operating</i>	60x63 mm	•	•	•	•	•	
ROLLBOX 660	Lucernario azionamento manuale <i>Hand drawn operatingskylight</i>	60x63 mm	•	•	•	•	•	•
ROLLBOX 760	Motorizzato a batterie <i>Battery motorized</i>	60x63 mm	•	•	•	•	•	

COLORI - COLOURS - COLORES - CORES - COLEURES - FARBEN - KLEUREN - ЦВЕТ



ON DEMAND

